

FULL CATALOGUE

LDR



THEATRICAL



TEMPO F 650 PLUS

LDR
LUCI DELLA RIBALTA

10601000 black

10601001 white

10601002 silver



PRODUCT SPECS

lens type
120mm dia. Fresnel

reflector
55mm dia. glass

microswitch
no

colour frame
150x150mm

throw
2-10m

beam angle
7°-60°

weight
4 kg

Quality yet budget-priced 500W or 650W Fresnel spotlight. It features a slide-focus variable-spread, soft edged beam which makes it ideal for small, intimate stage areas.

Also included as standard are a DIN standard colour frame, safety guard and 1,5m mains cable. Available to special order in any colour from the RAL range.

Illuminatore fresnel da 500/650W di elevato livello qualitativo e tuttavia di gamma economica.

Produce un fascio di luce regolabile molto morbido e soffuso, che lo rende ideale per l'utilizzo in scene di piccole dimensioni. Fornito di serie completo di telaio portagelatina, rete di protezione e 1,5m cavo di alimentazione.

ACCESSORIES

- 20100103 colour frame, black
- 20100103B colour frame, white
- 20100103C colour frame, silver
- 20100303 4-leaf barndoor, black
- 20100303B 4-leaf barndoor, white
- 20100303C 4-leaf barndoor, silver
- 20100303D 4-leaf barndoor, white/black
- 20100303E 4-leaf barndoor, silver/black
- 20100900 hook clamp
- 20101300 safety bond
- 20106013 colour scroller Xpress 13
- 20600003 plate 150x150mm for Xpress13

COMPATIBLE LAMPS

M38	GY9.5	300W	230V/240V	2950K	2000 hrs
M40	GY9.5	500W	230V/240V	2950K	2000 hrs
T18	GY9.5	500W	230V/240V	3000K	360 hrs
T25	GY9.5	500W	230V/240V	3000K	360 hrs
T26	GY9.5	650W	230V/240V	3050K	600 hrs
T27	GY9.5	650W	230V/240V	3050K	600 hrs

LDR recommends Philips lamps

PHOTOMETRIC DATA T27

	SPOT									
m Ø	0,2	0,4	0,5	0,6	0,7	0,9	1,0	1,1	1,2	
lux	16.600	7.378	4.150	2.656	1.844	1.355	1.038	820	664	
m	2	3	4	5	6	7	8	9	10	
	FLOOD									
m Ø	2,3	3,5	4,6	5,8	6,9	8,1	9,2	10,4	11,5	
lux	3.096	1.376	774	495	344	253	194	153	124	
m	2	3	4	5	6	7	8	9	10	

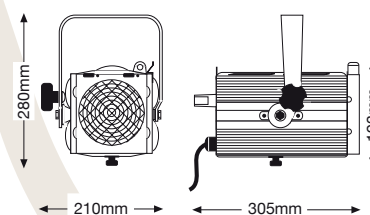

TEMPO F 650 PRO



10601200 black

10601201 white

10601202 silver



COMPATIBLE LAMPS

Model	Lamp Type	Power	Voltage	Temp	Life
M38	GY9.5	300W	230V/240V	2950K	2000 hrs
M40	GY9.5	500W	230V/240V	2950K	2000 hrs
T18	GY9.5	500W	230V/240V	3000K	360 hrs
T25	GY9.5	500W	230V/240V	3000K	360 hrs
T26	GY9.5	650W	230V/240V	3050K	600 hrs
T27	GY9.5	650W	230V/240V	3050K	600 hrs

LDR recommends Philips lamps

ACCESSORIES

20100103	colour frame, black
20100103B	colour frame, white
20100103C	colour frame, silver
20100303	4-leaf barndoor, black
20100303B	4-leaf barndoor, white
20100303C	4-leaf barndoor, silver
20100303D	4-leaf barndoor, white/black
20100303E	4-leaf barndoor, silver/black
20100900	hook clamp
20101300	safety bond
20106013	colour scroller Xpress 13
20600003	plate 150x150mm for Xpress13

PRODUCT SPECS

lens type
120mm dia. Fresnel

reflector
55mm dia. glass

microswitch
double-pole

colour frame
150x150mm

throw
2-10m

beam angle
7°-60°

weight
4 kg

Pro-version of the extremely popular Tempo f650 Plus, featuring a double-microswitch disconnecter for safe lamp replacement.

Tempo f650 Pro is a quality yet budget-priced 500W or 650W Fresnel spotlight. It features a slide-focus variable-spread, soft-edged beam which makes it ideal for small, intimate stage areas. Also included as standard are a DIN standard colour frame, safety guard and 1,5m mains cable.

Versione Pro dell'estremamente popolare Tempo f650 Plus, fornita di doppio microinterruttore di sicurezza.

Tempo f650 Pro è un illuminatore fresnel da 500 /650W di elevato livello qualitativo e tuttavia di gamma economica.

Produce un fascio di luce regolabile molto morbido e soffuso, che lo rende ideale per l'utilizzo in scene molto intime e di piccole dimensioni. Fornito di serie completo di telaio portagelatina, rete di protezione e 1,5m cavo di alimentazione.

PHOTOMETRIC DATA T27

SPOT	m Ø	0,2	0,4	0,5	0,6	0,7	0,9	1,0	1,1	1,2
	lux	16.600	7.378	4.150	2.656	1.844	1.355	1.038	820	664
	m	2	3	4	5	6	7	8	9	10
FLOOD	m Ø	2,3	3,5	4,6	5,8	6,9	8,1	9,2	10,4	11,5
	lux	3.096	1376	774	495	344	253	194	153	124
	m	2	3	4	5	6	7	8	9	10

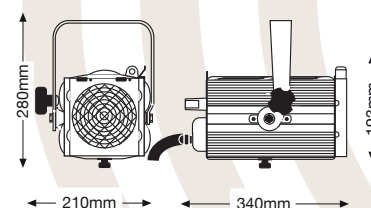

TEMPO PC 650 PLUS



PC 10602000 black

10602001 white

10602002 silver

PPC 10602100 black

10602101 white

10602102 silver



ACCESSORIES

20100103	colour frame, black
20100103B	colour frame, white
20100103C	colour frame, silver
20100303	4-leaf barndoor, black
20100303B	4-leaf barndoor, white
20100303C	4-leaf barndoor, silver
20100303D	4-leaf barndoor, white/black
20100303E	4-leaf barndoor, silver/black
20100900	hook clamp
20101300	safety bond
20106013	colour scroller Xpress 13
20600003	plate 150x150mm for Xpress13

Simple yet high-quality 650W PC spotlight featuring a slide-focus variable spread beam to offer more definition than the softer Fresnel beam.

Tempo pc650 plus is ideal for close projection in small stage venues and whenever budget is a priority.

A colour frame, safety guard and 1,5m mains cable are all included as standard.

illuminatore piano-convesso da 650W, compatto e versatile, adatto all'utilizzo su piccole scene o in ambiente amatoriale. Produce un fascio di luce intenso, omogeneo e ben definito.

Fornito di serie completo di telaio portagelatina, rete di protezione e 1,5m cavo di alimentazione.

PRODUCT SPECS

lens type
120mm dia. pebble-convex

reflector
55mm dia. glass

microswitch
no

colour frame
150x150mm

throw
2-10m

beam angle
7°-58°

weight
4,3 kg

COMPATIBLE LAMPS

Lamp	Base	Power	Voltage	Temp	Life
M38	GY9.5	300W	230V/240V	2950K	2000 hrs
M40	GY9.5	500W	230V/240V	2950K	2000 hrs
T18	GY9.5	500W	230V/240V	3000K	360 hrs
T25	GY9.5	500W	230V/240V	3000K	360 hrs
T26	GY9.5	650W	230V/240V	3050K	600 hrs
T27	GY9.5	650W	230V/240V	3050K	600 hrs

LDR recommends Philips lamps

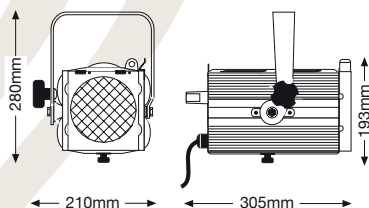

PHOTOMETRIC DATA T27

SPOT	m Ø	0,2	0,4	0,5	0,6	0,7	0,9	1,0	1,1	1,2
	lux		24.800	11.022	6.200	3.968	2.756	2.024	1.550	1.225
	m	2	3	4	5	6	7	8	9	10
FLOOD	m Ø	2,2	3,3	4,3	5,5	6,7	7,8	8,9	10,0	11,1
	lux		2.148	955	537	344	239	175	134	106
	m	2	3	4	5	6	7	8	9	10

TEMPO PC 650 PRO



10602200 black

10602201 white

10602202 silver



COMPATIBLE LAMPS

M38	GY9.5	300W	230V/240V	2950K	2000 hrs
M40	GY9.5	500W	230V/240V	2950K	2000 hrs
T18	GY9.5	500W	230V/240V	3000K	360 hrs
T25	GY9.5	500W	230V/240V	3000K	360 hrs
T26	GY9.5	650W	230V/240V	3050K	600 hrs
T27	GY9.5	650W	230V/240V	3050K	600 hrs

LDR recommends Philips lamps

ACCESSORIES

20100103	colour frame, black
20100103B	colour frame, white
20100103C	colour frame, silver
20100303	4-leaf barndoor, black
20100303B	4-leaf barndoor, white
20100303C	4-leaf barndoor, silver
20100303D	4-leaf barndoor, white/black
20100303E	4-leaf barndoor, silver/black
20100900	hook clamp
20101300	safety bond
20106013	colour scroller Xpress 13
20600003	plate 150x150mm for Xpress13

PRODUCT SPECS

lens type
120mm dia. pebble-convex

reflector
55mm glass

microswitch
double-pole

colour frame
150x150mm

throw
2-10m

beam angle
7°-58°

weight
4,3 kg

Pro-version of the extremely popular Tempo pc 650 Plus, featuring a double-microswitch disconnecter for safe lamp replacement.

Tempo pc650 Pro is a simple yet high quality 650W PC spotlight featuring a slide-focus variable-spread beam to offer more definition than the softer Fresnel beam.

Tempo pc650 Pro is ideal for close projection in small stage venues and whenever budget and safety are priority.

A colour frame, safety guard and 1,5m mains cable are all included as standard.

Versione Pro, dotata di doppio microinterruttore di sicurezza, dell'estremamente popolare Tempo pc650Plus. Tempo pc650Pro è un illuminatore piano-convesso da 650W, compatto e versatile, adatto all'utilizzo su piccole scene o in ambiente amatoriale.

Produce un fascio di luce intenso, omogeneo e ben definito. Fornito di serie completo di telaio portagelatina, rete di protezione e 1,5m cavo di alimentazione.

PHOTOMETRIC DATA T27

SPOT	m Ø	0,2	0,4	0,5	0,6	0,7	0,9	1,0	1,1	1,2
	lux	24.800	11.022	6.200	3.968	2.756	2.024	1.550	1.225	992
	m	2	3	4	5	6	7	8	9	10
FLOOD	m Ø	2,2	3,3	4,3	5,5	6,7	7,8	8,9	10,0	11,1
	lux	2.148	955	537	344	239	175	134	106	86
	m	2	3	4	5	6	7	8	9	10

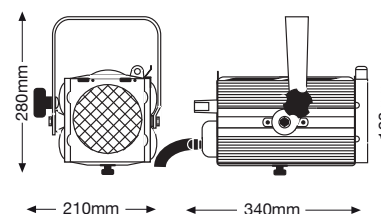

SUONO F 650 PLUS



10601010 black

10601011 white

10601012 silver



COMPATIBLE LAMPS

M38	GY9.5	300W	230V/240V	2950K	2000 hrs
M40	GY9.5	500W	230V/240V	2950K	2000 hrs
T18	GY9.5	500W	230V/240V	3000K	360 hrs
T25	GY9.5	500W	230V/240V	3000K	360 hrs
T26	GY9.5	650W	230V/240V	3050K	600 hrs
T27	GY9.5	650W	230V/240V	3050K	600 hrs

LDR recommends Philips lamps

PRODUCT SPECS

lens type

120mm dia. Fresnel

reflector

55mm dia. glass

microswitch

double-pole

colour frame

150x150mm

throw

2-10 m

beam angle

7°-60°

weight

4,1 kg

Compact, quality 500W/650W Fresnel spotlight, ideal for professional applications in smaller venues. The soft-edged beam is adjustable by a screw-focus mechanism, and the design also includes a glass reflector and a double-microswitch interlock for safe lamp replacement.

A colour frame, safety guard and 1,5m mains cable are all included as standard.

Illuminatore fresnel da 500/650W per uso professionale su piccole scene. Produce un fascio di luce molto morbido, regolato da accurata messa a fuoco con vite senza fine. E' dotato di specchio in vetro, di un efficace sistema di bloccaggio forcilla e di doppio microinterruttore di sicurezza.

Fornito di serie completo di telaio portagelatina, rete di protezione e 1,5m cavo di alimentazione.

ACCESSORIES

20100103	colour frame, black
20100103B	colour frame, white
20100103C	colour frame, silver
20100303	4-leaf barndoor, black
20100303B	4-leaf barndoor, white
20100303C	4-leaf barndoor, silver
20100303D	4-leaf barndoor, white/black
20100303E	4-leaf barndoor, silver/black
20100900	hook clamp
20101300	safety bond
20106013	colour scroller Xpress 13
20600003	plate 150x150mm for Xpress13

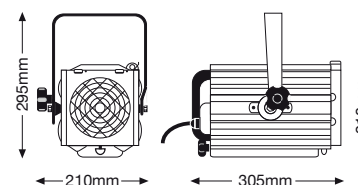

PHOTOMETRIC DATA T27

SPOT	m Ø	0,2	0,4	0,5	0,6	0,7	0,9	1,0	1,1	1,2
	lux	16.600	7.378	4.150	2.656	1.844	1.355	1.038	820	664
	m	2	3	4	5	6	7	8	9	10
FLOOD	m Ø	2,3	3,5	4,6	5,8	6,9	8,1	9,2	10,4	11,5
	lux	3.096	1.376	774	495	344	253	194	153	124
	m	2	3	4	5	6	7	8	9	10

SUONO PC 650 PLUS



PC 10602010 black

10602011 white

10602012 silver

PPC 10602110 black

10602111 white

10602112 silver



COMPATIBLE LAMPS

Code	Wattage	Voltage	Temp. (K)	Life (hrs)
M38	GY9.5 300W	230V/240V	2950K	2000 hrs
M40	GY9.5 500W	230V/240V	2950K	2000 hrs
T18	GY9.5 500W	230V/240V	3000K	360 hrs
T25	GY9.5 500W	230V/240V	3000K	360 hrs
T26	GY9.5 650W	230V/240V	3050K	600 hrs
T27	GY9.5 650W	230V/240V	3050K	600 hrs

LDR recommends Philips lamps

ACCESSORIES

20100103	colour frame, black
20100103B	colour frame, white
20100103C	colour frame, silver
20100303	4-leaf barndoor, black
20100303B	4-leaf barndoor, white
20100303C	4-leaf barndoor, silver
20100303D	4-leaf barndoor, white/black
20100303E	4-leaf barndoor, silver/black
20100900	hook clamp
20101300	safety bond
20106013	colour scroller Xpress 13
20600003	plate 150x150mm for Xpress13

PRODUCT SPECS

lens type
120mm dia. pebble-convex

reflector
55mm dia. glass

microswitch
double-pole

colour frame
150x150mm

throw
2-10m

beam angle
7°-58°

weight
4,4 kg

Quality 500/650W PC spotlight ideal for professional usage in smaller venues. The well-defined beam is adjustable by a screw-focus mechanism, and the design also includes a hinged lamp-tray and a double-microswitch interlock for safe lamp replacement.

A colour frame, safety guard and 1,5m mains cable are all included as standard.

Illuminatore piano-convesso da 500/650W per uso professionale su piccole scene. Produce un fascio di luce molto omogeneo. E' dotato di carrello porta-lampada basculante ad apertura frontale e di doppio microinterruttore di sicurezza.

Fornito di serie completo di telaio portagelatina, rete di protezione e 1,5m cavo di alimentazione.

	m	2	3	4	5	6	7	8	9	10
SPOT	m Ø	0,2	0,4	0,5	0,6	0,7	0,9	1,0	1,1	1,2
	lux	24.800	11.022	6.200	3.968	2.756	2.024	1.550	1.225	992
	m	2	3	4	5	6	7	8	9	10
FLOOD	m Ø	2,2	3,3	4,3	5,5	6,7	7,8	8,9	10,0	11,1
	lux	2.148	955	537	344	239	175	134	106	86
	m	2	3	4	5	6	7	8	9	10

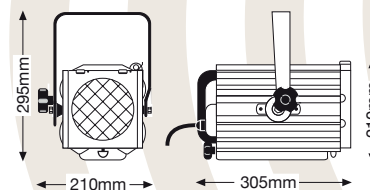

ARIA F 1000 PLUS



10801000 black

10801001 white

10801002 silver



COMPATIBLE LAMPS

CP67	GX9.5	650W	230V/240V	3200K	120 hrs
T21	GX9.5	650W	230V/240V	3000K	900 hrs
CP70	GX9.5	1000W	230V/240V	3200K	240 hrs
T19	GX9.5	1000W	230V/240V	3050K	900 hrs
CP90	GX9.5	1200W	230V/240V	3200K	240 hrs
T29	GX9.5	1200W	230V/240V	3000K	480 hrs

LDR recommends Philips lamps

PRODUCT SPECS

lens type

150 mm dia. Fresnel

reflector

100 mm dia. aluminium

microswitch

no

colour frame

185x185 mm

throw

2-15 m

beam angle

10°-56°

weight

5,6 kg

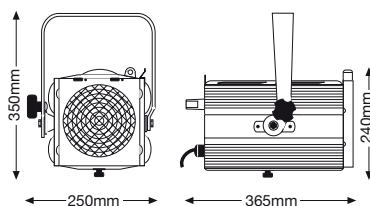

Quality, yet budget-priced, versatile 650W-1200W fresnel spotlight producing a variable-spread soft-edged beam.

It is ideal for general stage lighting illumination in medium-sized venues and is supplied with a colour frame, safety guard and 1,5m mains cable. A full range of accessories in different colours is available as optional extra.

Versatile illuminatore fresnel da 1000/1200W, di gamma economica e tuttavia di elevato standard qualitativo, che produce un fascio di luce regolabile e dai bordi soffici.

Particolarmente indicato per l'illuminazione generale di scena su distanze medio lunghe. Viene fornito di serie completo di telaio portagelatina, rete di protezione e 1,5m cavo di alimentazione, mentre un'ampia gamma di accessori è disponibile come optional.

ACCESSORIES

20100106	colour frame, black
20100106B	colour frame, white
20100106C	colour frame, silver
20100306	4-leaf barndoor, black
20100306B	4-leaf barndoor, white
20100306C	4-leaf barndoor, silver
20100306D	4-leaf barndoor, white/black
20100306E	4-leaf barndoor, silver/black
20100900	hook clamp
20101300	safety bond
20106019	colour scroller Xpress 19
20600006	plate 185x185mm for Xpress 19

PHOTOMETRIC DATA CP90

	m Ø	1,2	1,4	1,6	1,7	1,9	2,1	2,3	2,4	2,6
SPOT	lux	2.612	2.000	1.580	1.280	1.058	889	757	653	569
	m	7	8	9	10	11	12	13	14	15
FLOOD	m Ø	2,1	3,2	4,3	5,3	6,4	7,4	8,5	9,6	10,6
	lux	3.200	1.422	800	512	356	261	200	158	128
	m	2	3	4	5	6	7	8	9	10

ARIA PC 1000 PLUS



PC 10802000 black	PPC 10802100 black
10802001 white	10802101 white
10802002 silver	10802102 silver



COMPATIBLE LAMPS

CP67	GX9.5	650W	230V/240V	3200K	120 hrs
T21	GX9.5	650W	230V/240V	3000K	900 hrs
CP70	GX9.5	1000W	230V/240V	3200K	240 hrs
T19	GX9.5	1000W	230V/240V	3050K	900 hrs
CP90	GX9.5	1200W	230V/240V	3200K	240 hrs
T29	GX9.5	1200W	230V/240V	3000K	480 hrs

LDR recommends Philips lamps

ACCESSORIES

20100106	colour frame, black
20100106B	colour frame, white
20100106C	colour frame, silver
20100306	4-leaf barndoor, black
20100306B	4-leaf barndoor, white
20100306C	4-leaf barndoor, silver
20100306D	4-leaf barndoor, white/black
20100306E	4-leaf barndoor, silver/black
20100900	hook clamp
20101300	safety bond
20106019	colour scroller Xpress 19
20600006	plate 185x185mm for Xpress 19

PRODUCT SPECS

lens type
150mm dia. pebble-convex

reflector
100mm dia. aluminium

microswitch
no

colour frame
185x185mm

throw
2-17m

beam angle
8°-60°

weight
6 kg

Compact, high-quality yet budget-priced 650W- 1200W PC spotlight producing a variable, well defined beam ranging from 8° to 60°. It is ideal for non professional applications in medium-sized venues. A colour frame, safety guard and 1,5m mains cable are all included as standard.

Illuminatore piano-convesso da 1000/1200W, di elevato standard qualitativo e tuttavia di gamma economica. Produce un fascio di luce dai bordi ben definiti e regolabile tra 8° e 60°.

E' particolarmente indicato in utilizzi non professionali su distanze medio-lunghe. Fornito di serie completo di telaio portagelatina, rete di protezione e 1,5 m cavo di alimentazione.

PHOTOMETRIC DATA CP90

	m Ø	1,0	1,1	1,3	1,4	1,5	1,7	1,8	2,0	2,1
SPOT	lux	4.996	3.825	3.022	2.448	2.032	1.700	1.449	1.249	1.088
	m	7	8	9	10	11	12	13	14	15
	m Ø	2,3	3,5	4,6	5,8	6,9	8,1	9,2	10,4	11,5
FLOOD	lux	2.440	1.084	610	390	271	199	153	120	98
	m	2	3	4	5	6	7	8	9	10

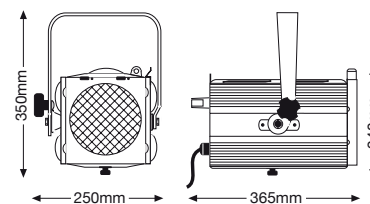



NOTA F 1200 PLUS



10851000 230V black 11851000 120V black

10851001 230V white 11851001 120V white

10851002 230V silver 11851002 120V silver



ACCESSORIES

20100106	colour frame, black
20100106B	colour frame, white
20100106C	colour frame, silver
20100306	4-leaf barndoor, black
20100306B	4-leaf barndoor, white
20100306C	4-leaf barndoor, silver
20100306D	4-leaf barndoor, white/black
20100306E	4-leaf barndoor, silver/black
20100900	hook clamp
20101300	safety bond
20106019	colour scroller Xpress 19
20600006	plate 185x185mm for Xpress 19

Quality 1/1200W fresnel spotlight including screw focus variable spread soft-edged beam, front hinging lamp tray, tilt lock and double microswitch interlock for safe lamp replacement. A colour frame, safety guard and 1,5m mains cable are included as standard.

illuminatore fresnel da 1000/1200W di elevata qualità ottica. Dispone di messa a fuoco di precisione con vite senza fine, sportello portalamпада basculante, efficace sistema di bloccaggio forcella e doppio microinterruttore di sicurezza. Fornito di serie completo di telaio portagelatina, rete di protezione e 1,5m cavo di alimentazione.

PRODUCT SPECS

lens type	150mm dia. Fresnel
reflector	100mm dia. aluminium
microswitch	double-pole
colour frame	185x185 mm
throw	2-15 m
beam angle	10°-56°
lamp base	GX9,5 (230V) - G22 (120V)
weight	5,8 kg (230V) - 6,0 kg (120V)

COMPATIBLE LAMPS

CP67	GX9.5	650W	230V/240V	3200K	120 hrs
T21	GX9.5	650W	230V/240V	3000K	900 hrs
CP70	GX9.5	1000W	230V/240V	3200K	240 hrs
T19	GX9.5	1000W	230V/240V	3050K	900 hrs
CP90	GX9.5	1200W	230V/240V	3200K	240 hrs
T29	GX9.5	1200W	230V/240V	3000K	480 hrs
EGT	G22	1000W	120V/240V	3200K	300 hrs

LDR recommends Philips lamps

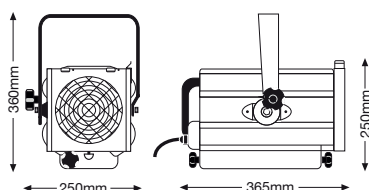

PHOTOMETRIC DATA CP90

SPOT	m Ø	1,2	1,4	1,6	1,7	1,9	2,1	2,3	2,4	2,6
	lux	2.612	2.000	1.580	1.280	1.058	889	757	653	569
	m	7	8	9	10	11	12	13	14	15
FLOOD	m Ø	2,1	3,2	4,3	5,3	6,4	7,4	8,5	9,6	10,6
	lux	3.200	1.422	800	512	356	261	200	158	128
	m	2	3	4	5	6	7	8	9	10

NOTA PC 1200 PLUS



10852000 230V black	11852000 120V black	PPC 10852100 black
10852001 230V white	11852001 120V white	10852101 white
10852002 230V silver	11852002 120V silver	10852102 silver



COMPATIBLE LAMPS

CP67	GX9.5	650W	230V/240V	3200K	120 hrs
T21	GX9.5	650W	230V/240V	3000K	900 hrs
CP70	GX9.5	1000W	230V/240V	3200K	240 hrs
T19	GX9.5	1000W	230V/240V	3050K	900 hrs
CP90	GX9.5	1200W	230V/240V	3200K	240 hrs
T29	GX9.5	1200W	230V/240V	3000K	480 hrs
EGT	G22	1000W	120V	3200K	300 hrs

LDR recommends Philips lamps

ACCESSORIES

20100106	colour frame, black
20100106B	colour frame, white
20100106C	colour frame, silver
20100306	4-leaf barndoor, black
20100306B	4-leaf barndoor, white
20100306C	4-leaf barndoor, silver
20100306D	4-leaf barndoor, white/black
20100306E	4-leaf barndoor, silver/black
20100900	hook clamp
20101300	safety bond
20106019	colour scroller Xpress 19
20600006	plate 185x185mm for Xpress 19

Quality 1/1200W PC spotlight with a screw focus variable-spread tight-edged beam, an easily adjustable lamp position for either 1000W or 1200W lamps, effective tilt lock and double-microswitch interlock for safe lamp replacement.

A colour frame, safety guard and 1,5m mains cable are included as standard.

Illuminatore piano-convesso da 1000/1200W per uso professionale, dal fascio di luce estremamente omogeneo e definito. Dispone di un semplice sistema di riposizionamento lampada, efficace sistema di bloccaggio forcella e doppio microinterruttore di sicurezza. Fornito di serie completo di telaio portagelatina, rete di protezione e 1,5m cavo di alimentazione.

PRODUCT SPECS

lens type
150mm dia. pebble-convex

reflector
100mm dia. aluminium

microswitch
double-pole

colour frame
185x185mm

throw
2-17 m

beam angle
8°-60°

lamp base
GX9.5 (230V) - G22 (120V)

weight
6,2 kg (230V) - 6,4 kg(120V)

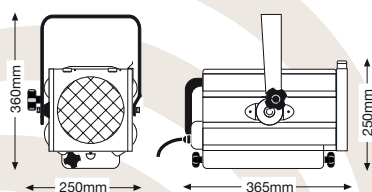

PHOTOMETRIC DATA CP90

SPOT	m Ø	1,3	1,4	1,5	1,7	1,8	2,0	2,1	2,2	2,4
	lux		3.022	2.448	2.023	1.700	1.449	1.249	1.088	956
	m	9	10	11	12	13	14	15	16	17
FLOOD	m Ø	2,3	3,5	4,6	5,8	6,9	8,1	9,2	10,4	11,5
	lux		2.440	1.084	610	390	271	199	154	120
	m	2	3	4	5	6	7	8	9	10

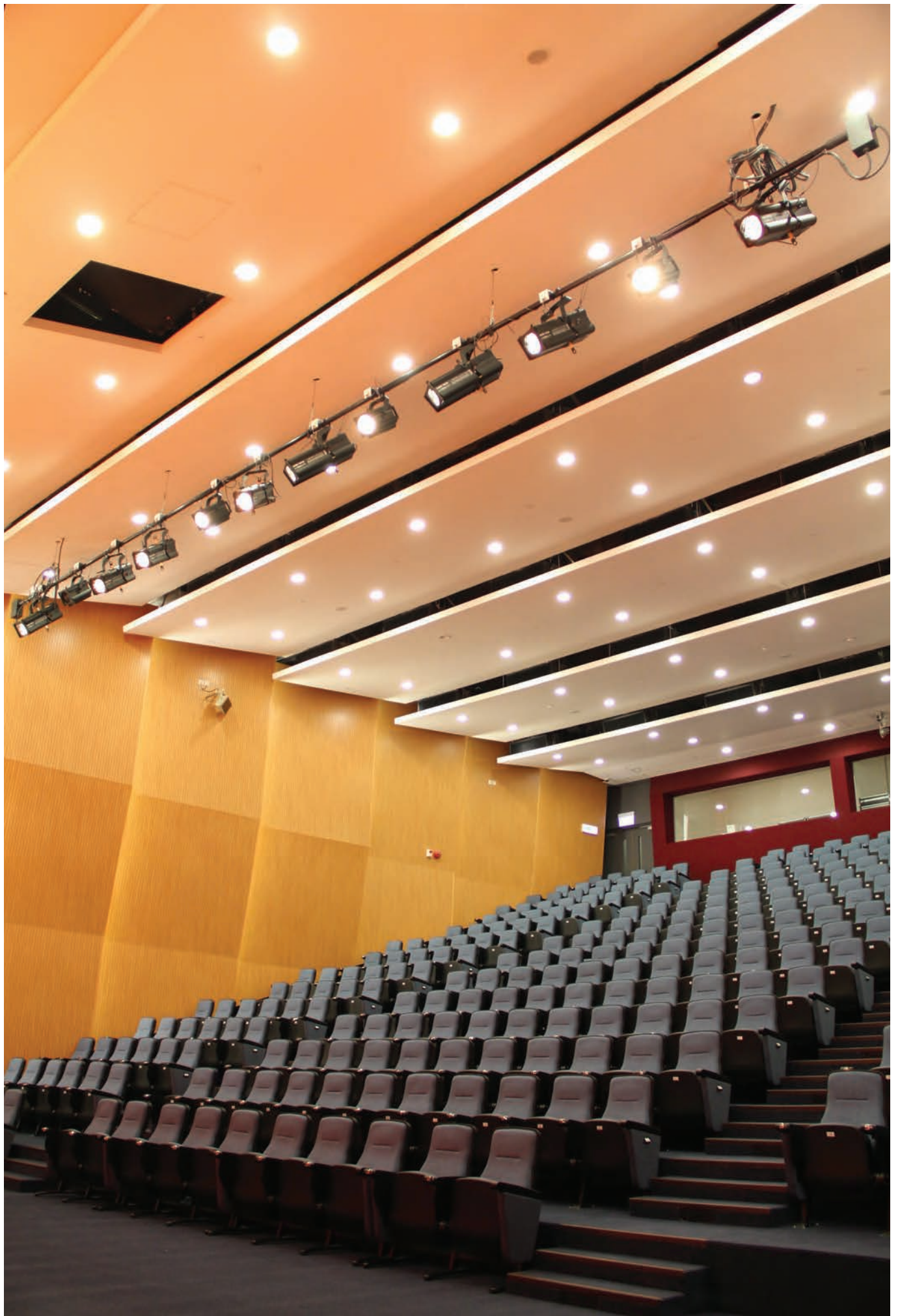

TONO F 2000 PLUS



10901000 230V black

11901000 120V black



COMPATIBLE LAMPS

CP55	G22	2000W	230V/240V	3200K	480 hrs
CP75	G22	2000W	230V/240V	3200K	480 hrs
CP92	G22	2000W	230V/240V	3200K	400 hrs
CP72	GY16	2000W	230V/240V	3200K	480 hrs
CP91	G22	2500W	230V/240V	3200K	400 hrs
CYX	G38	2000W	120V	3200K	350 hrs

LDR recommends Philips lamps

PRODUCT SPECS

lens type

200mm dia. Fresnel

reflector

87,5mm dia. glass

microswitch

double-pole

colour frame

245x245mm

throw

3-20 m

beam angle

10°-70°

lamp base

G22 (230V) - G38 (120V)

weight

9,0 kg (230V) - 10,1 kg (120V)

ACCESSORIES

20100107	colour frame, black
20100307	4-leaf barndoor, black
20101000	hook clamp HD
20101300	safety bond
20106026	colour scroller Xpress 26
20600007	plate 245x245mm for Xpress 26

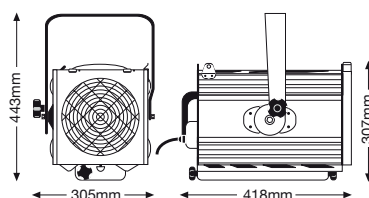

Compact, lightweight and powerful 2/2.5KW fresnel spotlight. It features an extremely wide beam angle and includes a height adjustable, robust G22 lamp-base, screw focus, strong tilt lock and double microswitch interlock for safe lamp replacement. A colour frame, safety guard and 1,5m mains cable are included as standard.

illuminatore fresnel da 2/2500W estremamente compatto, leggero e potente.

Dispone di robusto portalampada G22 regolabile in altezza, messa a fuoco di precisione con vite senza fine, bloccaggio forcella a frizione e doppio microinterruttore di sicurezza. Fornito di serie completo di telaio portagelatina, rete di protezione e 1,5m cavo di alimentazione.

PHOTOMETRIC DATA CP75

	m Ø	2,3	2,5	2,7	2,9	3,1	3,3	3,5	3,7	3,9
SPOT	lux	1.563	1.331	1.148	1.000	879	779	694	623	563
	m	12	13	14	15	16	17	18	19	20
FLOOD	m Ø	4,2	5,6	7,0	8,4	9,8	11,2	12,6	14,0	15,4
	lux	2.200	1.238	792	550	404	309	244	198	164
	m	3	4	5	6	7	8	9	10	11

On request also available with GY16 lamp-base (230V only).

Su richiesta disponibile anche con porta-lampada GY16 (solo 230V).

TONO PC 2000 PLUS



PC 10902000 230V black
11902000 120V black

PPC 10902100 230V black
11902100 120V black



COMPATIBLE LAMPS

CP55	G22	2000W	230V/240V	3200K	480 hrs
CP75	G22	2000W	230V/240V	3200K	480 hrs
CP92	G22	2000W	230V/240V	3200K	400 hrs
CP72	GY16	2000W	230V/240V	3200K	480 hrs
CP91	G22	2500W	230V/240V	3200K	400 hrs
CYX	G38	2000W	120V	3200K	350 hrs

LDR recommends Philips lamps

PRODUCT SPECS

lens type
200mm dia. pebble-convex

reflector
87,5mm dia. glass

microswitch
double-pole

colour frame
245x245mm

throw
3-20m

beam angle
9°-70°

lamp base
G22 (230V) - G38 (120V)

weight
10,3 kg (230V) - 11,4 kg (120V)

ACCESSORIES

- 20100107 colour frame, black
- 20100307 4-leaf barndoor, black
- 20101000 hook clamp HD
- 20101300 safety bond
- 20106026 colour scroller Xpress 26
- 20600007 plate 245x245mm for Xpress 26

Compact, lightweight and multifeatured 2/2.5KW pc spotlight for larger venues. It features an extremely wide beam angle and includes a front hinging lamp tray, a robust G22 lamp-base, screw focus, strong tilt lock and double-microswitch interlock for safe lamp replacement. A colour frame, safety guard and 1,5m mains cable are included as standard.

Illuminatore piano-convesso da 2/2500W per uso professionale in grandi ambienti. Dispone di sportello portalam-pada basculante, robusto anello di ancoraggio secondario, efficace sistema di bloccaggio forcella e doppio microinterruttore di sicurezza. Fornito di serie completo di telaio portagelatina, rete di protezione e 1,5m cavo di alimentazione.

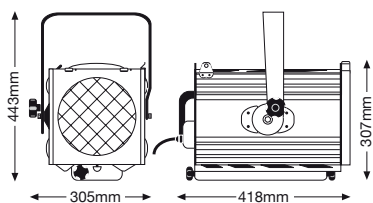

PHOTOMETRIC DATA CP75

SPOT	m Ø	1,9	2,0	2,2	2,4	2,5	2,7	2,8	3,0	3,1
	lux	2.625	2.237	1.929	1.680	1.477	1.308	1.167	1.047	945
	m	12	13	14	15	16	17	18	19	20
FLOOD	m Ø	4,2	5,6	7,0	8,4	9,8	11,2	12,6	14,0	15,4
	lux	2.700	1.519	972	675	496	380	300	243	201
	m	3	4	5	6	7	8	9	10	11

On request also available with GY16 lamp-base (230V only).

Su richiesta disponibile anche con porta-lampada GY16 (solo 230V).

SUONO 10/28 PLUS



10604020 black

10604021 white

10604022 silver



COMPATIBLE LAMPS

M38	GY9.5	300W	230V/240V	2950K	2000 hrs
M40	GY9.5	500W	230V/240V	2950K	2000 hrs
T18	GY9.5	500W	230V/240V	3000K	360 hrs
T25	GY9.5	500W	230V/240V	3000K	360 hrs
T26	GY9.5	650W	230V/240V	3050K	600 hrs
T27	GY9.5	650W	230V/240V	3050K	600 hrs

LDR recommends Philips lamps

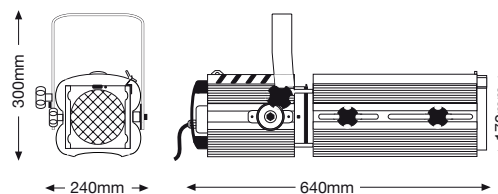

PRODUCT SPECS

lens type
double condenser+zoom

reflector
55mm dia. aluminium

microswitch
double-pole

colour frame
125x125mm

throw
2-15m

beam angle
10°-28°

weight
7,5 kg

ACCESSORIES

20100102	colour frame, black
20100102B	colour frame, white
20100102C	colour frame, silver
20100707	iris diaphragm
20100801	gobo holder, M/D size
20100900	hook clamp
20101300	safety bond
20106013	colour scroller Xpress 13
20600002	plate 125x125mm for Xpress13

Compact and high-specification 500W/650W profile spotlight with a double-condenser zoom focus optical system to provide crisp projection of gobos and a brilliant flat beam between 10° and 28°. Features include a rotating gate, zoom controls on teflon sleeves, hinged lamp tray and double microswitch interlock for safe lamp replacement.

A colour frame, safety guard, 4 beam shutters and 1,5m mains cable are all included as standard.

Sagomatore da 650W con sistema ottico a doppio condensatore, dall' eccellente precisione e nitida proiezione di gobo. Dispone di alloggiamento ghigliottine girevole, movimento zoom su supporti in teflon e doppio microinterruttore di sicurezza. Fornito di serie completo di telaio portagelatina, rete di protezione, 4 ghigliottine sagomatrici e 1,5m cavo di alimentazione.

PHOTOMETRIC DATA T27

NARROW	m Ø	1,2	1,4	1,6	1,7	1,9	2,1	2,3	2,4	2,6
	lux	1.071	820	648	525	434	365	311	268	233
	m	7	8	9	10	11	12	13	14	15
WIDE	m Ø	1	1,5	2	2,5	3	3,5	4	4,5	5
	lux	6.625	2.944	1.656	1.060	736	541	414	327	265
	m	2	3	4	5	6	7	8	9	10

SUONO 20/40 PLUS



10604030 black

10604031 white

10604032 silver



COMPATIBLE LAMPS

M38	GY9.5	300W	230V/240V	2950K	2000 hrs
M40	GY9.5	500W	230V/240V	2950K	2000 hrs
T18	GY9.5	500W	230V/240V	3000K	360 hrs
T25	GY9.5	500W	230V/240V	3000K	360 hrs
T26	GY9.5	650W	230V/240V	3050K	600 hrs
T27	GY9.5	650W	230V/240V	3050K	600 hrs

LDR recommends Philips lamps

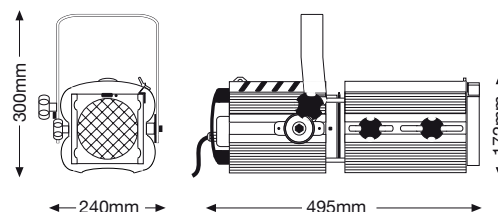

ACCESSORIES

20100102	colour frame, black
20100102B	colour frame, white
20100102C	colour frame, silver
20100707	iris diaphragm
20100801	gobo holder, M/D size
20100900	hook clamp
20101300	safety bond
20106013	colour scroller Xpress 13
20600002	plate 125x125mm for Xpress13

PRODUCT SPECS

optical system
double condenser + zoom

reflector
55mm dia. aluminium

microswitch
double-pole

colour frame
125x125mm

throw
2-15m

beam angle
20°-40°

weight
7 kg

This versatile 500W/650W profile spotlight, designed for shorter throws, has a double condenser zoom focus optical system to provide crisp projection of gobos and a brilliant flat beam of between 20° and 40°. Features include a rotating gate, insulated rear handle, hinged lamp tray and double microswitch interlock for safe lamp replacement.

A colour frame, safety guard, 4 beam shutters and 1,5m mains cable are all included as standard.

Sagomatore da 650W con sistema ottico a doppio condensatore, dall'eccellente precisione e nitida proiezione di gobo. Dispone di alloggiamento ghigliottine girevole, movimento zoom su supporti in teflon e doppio microinterruttore di sicurezza. Fornito di serie completo di telaio porta-gelatina, rete di protezione, 4 ghigliottine sagomatrici e 1,5m cavo di alimentazione.

PHOTOMETRIC DATA T27

	m Ø	2,5	2,8	3,2	3,5	3,9	4,2	4,6	4,9	5,3
NARROW	lux	1.005	770	608	493	407	342	291	251	219
	m	7	8	9	10	11	12	13	14	15
	m Ø	1,5	2,2	2,9	3,6	4,4	5,1	5,8	6,6	7,3
WIDE	lux	9.125	4.056	2.281	1.460	1.014	745	570	451	365
	m	2	3	4	5	6	7	8	9	10

- 10853020 black
- 10853021 white
- 10853022 silver



COMPATIBLE LAMPS

CP67	GX9.5	650W	230V/240V	3200K	120 hrs
T21	GX9.5	650W	230V/240V	3000K	900 hrs
CP70	GX9.5	1000W	230V/240V	3200K	240 hrs
T19	GX9.5	1000W	230V/240V	3050K	900 hrs
CP90	GX9.5	1200W	230V/240V	3200K	240 hrs
T29	GX9.5	1200W	230V/240V	3000K	480 hrs

LDR recommends Philips lamps

ACCESSORIES

- 20100106 colour frame, black
- 20100706 iris diaphragm
- 20100806 gobo holder, A/B size
- 20100900 hook clamp
- 20101300 safety bond
- 20106019 colour scroller Xpress 19
- 20600006 plate 185x185mm for Xpress 19

A high-specification 1000/1200W profile spotlight with advanced features including a double condenser optical system for extremely sharp gobo projection, rotating 4-shutter gate, 8° to 22° narrow-angle zoom focus, a double-microswitch interlock for safe lamp replacement, easy access for lens cleaning and a cranked fork. Ideal for front-of-house projection positions. A colour frame, safety guard, 4 beam shutters and 2m mains cable are all included as standard.

Sagomatore da 1000/1200W ad angolo stretto e dall'elevato profilo tecnico-qualitativo. Dispone di ottica primaria a doppio condensatore per una precisa proiezione gobo, di gruppo centrale girevole, ottica secondaria a tre elementi, doppio microinterruttore e blocco forcella a leva. Fornito di serie completo di telaio portagelatina, rete di protezione, 4 ghigliottine sagomatrici e 2m cavo di alimentazione.

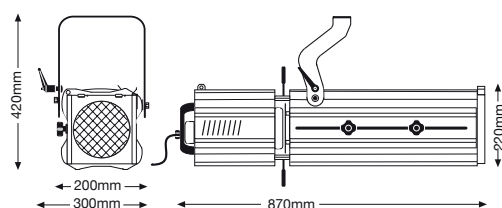

PRODUCT SPECS

optical system
double condenser+zoom

reflector
68mm dia. glass

microswitch
double-pole

colour frame
185x185mm

throw
5-25m

beam angle
8°-22°

weight
14,3 kg

PHOTOMETRIC DATA CP90

	m Ø	1,7	1,8	2	2,1	2,2	2,4	2,5	2,7	2,8
NARROW	lux	2.118	1.805	1.556	1.356	1.191	1.055	941	845	763
	m	12	13	14	15	16	17	18	19	20
WIDE	m Ø	1,9	2,3	2,7	3,1	3,5	3,9	4,3	4,7	5,1
	lux	6.160	4.278	3.143	2.406	1.901	1.540	1.273	1.069	911
	m	5	6	7	8	9	10	11	12	13

- 10853030 black
- 10853031 white
- 10853032 silver



COMPATIBLE LAMPS

CP67	GX9.5	650W	230V/240V	3200K	120 hrs
T21	GX9.5	650W	230V/240V	3000K	900 hrs
CP70	GX9.5	1000W	230V/240V	3200K	240 hrs
T19	GX9.5	1000W	230V/240V	3050K	900 hrs
CP90	GX9.5	1200W	230V/240V	3200K	240 hrs
T29	GX9.5	1200W	230V/240V	3000K	480 hrs

LDR recommends Philips lamps

This wide-angle 1000/1200W profile spotlight includes high-specification double condenser optical system for clean, crisp gobo projection.

The comprehensive feature list includes 18° - 36° zoom focus, rotating gate with 4 shutters, a cranked fork to accommodate acute overstage rigging angles and a double-microswitch interlock for safe lamp replacement. A colour frame, safety guard, 4 beam shutters and 2m mains cable are also included.

Sagomatore da 1000/1200W ad angolo largo e dall'elevato profilo tecnico-qualitativo. Dispone di ottica primaria a doppio condensatore per una precisa proiezione gobo, di gruppo centrale girevole, ottica secondaria a tre elementi, doppio microinterruttore e blocco forcilla a leva. Fornito di serie completo di telaio portagelatina, rete di protezione, 4 ghigliottine sagomatrici e 2m cavo di alimentazione.

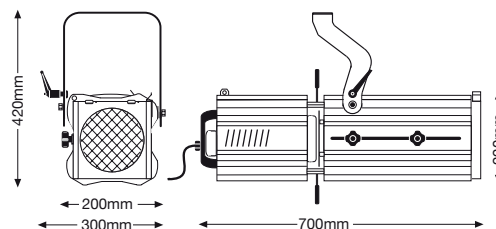

ACCESSORIES

- 20100106 colour frame, black
- 20100706 iris diaphragm
- 20100806 gobo holder, A/B size
- 20100900 hook clamp
- 20101300 safety bond
- 20106019 colour scroller Xpress 19
- 20600006 plate 185x185mm for Xpress 19

PRODUCT SPECS

- optical system**
double condenser+zoom
- reflector**
68mm dia. glass
- microswitch**
double-pole
- colour frame**
185x185mm
- throw**
5-18m
- beam angle**
18°-36°
- weight**
12,3 kg

PHOTOMETRIC DATA CP90

	m Ø	3,8	4,1	4,4	4,8	5,1	5,4	5,7	6,0	6,3
NARROW	lux	1.528	1.302	1.122	978	859	761	679	609	550
	m	12	13	14	15	16	17	18	19	20
WIDE	m Ø	4,5	5,2	5,8	6,5	7,1	7,8	8,4	9,1	9,7
	lux	1.082	828	654	530	438	368	314	270	236
	m	5	6	7	8	9	10	11	12	13

- 10853040 black
- 10853041 white
- 10853042 silver



COMPATIBLE LAMPS

CP67	GX9.5	650W	230V/240V	3200K	120 hrs
T21	GX9.5	650W	230V/240V	3000K	900 hrs
CP70	GX9.5	1000W	230V/240V	3200K	240 hrs
T19	GX9.5	1000W	230V/240V	3050K	900 hrs
CP90	GX9.5	1200W	230V/240V	3200K	240 hrs
T29	GX9.5	1200W	230V/240V	3000K	480 hrs

LDR recommends Philips lamps

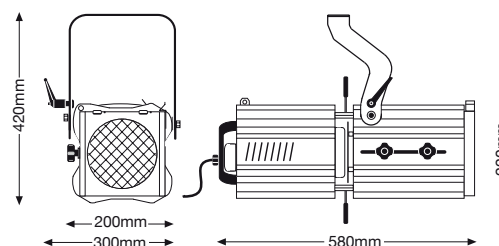

ACCESSORIES

- 20100106 colour frame, black
- 20100706 iris diaphragm
- 20100806 gobo holder, A/B size
- 20100900 hook clamp
- 20101300 safety bond
- 20106019 colour scroller Xpress 19
- 20600006 plate 185x185mm for Xpress 19

PRODUCT SPECS

optical system
double condenser+zoom

reflector
68mm dia. glass

microswitch
double-pole

colour frame
185x185mm

throw
4-12m

beam angle
30°-55°

weight
11,9 kg

This extremely wide-angle 1000/1200W profile spotlight includes high-specification double condenser optical system for clean, crisp gobo projection. The comprehensive feature list includes 30° - 55° zoom focus, rotating gate with 4 shutters, a cranked fork to accommodate acute over-stage rigging angles and a double microswitch interlock for safe lamp replacement. A colour frame, safety guard, 4 beam shutters and 2m mains cable are also included.

Sagomatore da 1000/1200W ad angolo estremamente largo e dall'elevato profilo tecnico-qualitativo. Dispone di ottica primaria a doppio condensatore per una precisa proiezione gobo, di gruppo centrale girevole, ottica secondaria a tre elementi, doppio microinterruttore e blocco forcella a leva. Fornito di serie completo di telaio portagelatina, rete di protezione, 4 ghigliottine sagomatrici e 2m cavo di alimentazione.

PHOTOMETRIC DATA CP90

	m Ø	2,1	2,7	3,2	3,8	4,3	4,8	5,4	5,9	6,4
NARROW	lux	5.594	3.580	2.486	1.827	1.398	1.105	895	740	622
	m	4	5	6	7	8	9	10	11	13
	m Ø	4,2	5,2	6,2	7,3	8,3	9,4	10,4	11,5	12,5
WIDE	lux	1.494	956	664	488	373	295	239	198	166
	m	4	5	6	7	8	9	10	11	13



COMPATIBLE LAMPS

CP72 GY16 2000W 230V/240V 3200K 480 hrs

LDR recommends Philips lamps

ACCESSORIES

- 20100106 colour frame, black
- 20100706 iris diaphragm
- 20100806 gobo holder, A/B size
- 20100900 hook clamp
- 20101300 safety bond
- 20106019 colour scroller Xpress 19
- 20600006 plate 185x185mm for Xpress 19

This powerful 2Kw narrow-angle profile spotlight is designed for use in larger venues which demand exceptional beam quality and gobo projection. In addition to a double condenser optical system, features include an 8° - 22° zoom focus, rotating gate, a cranked fork and a double-microswitch interlock for safe lamp replacement. A colour frame, safety guard, 4 beam shutters and 2m mains cable are also supplied as standard.

Sagomatore da 2000W ad angolo stretto progettato per l'impiego in grandi installazioni che richiedano un'eccezionale qualità ottica ed un'estremamente nitida proiezione gobo. Oltre che di un doppio condensatore ottico dispone di angolo di proiezione tra 8° e 22°, alloggiamento ghigliottine girevole, blocco forcilla a leva e doppio microinterruttore. Fornito di serie completo di telaio portagelatina, rete di protezione, 4 ghigliottine sagomatrici e 2m cavo di alimentazione.

PRODUCT SPECS

lens type
double condenser+zoom

reflector
68mm dia. glass

microswitch
double-pole

colour frame
185x185mm

throw
6-30m

beam angle
8°-22°

weight
14,7 kg

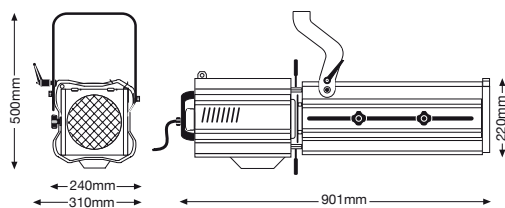

PHOTOMETRIC DATA CP72

NARROW	m Ø	2,0	2,2	2,5	2,8	3,1	3,4	3,6	3,9	4,2
	lux	2.443	1.870	1.478	1.197	989	831	708	611	532
	m	14	16	18	20	22	24	26	28	30
WIDE	m Ø	2,3	3,1	3,9	4,7	5,4	6,2	7,0	7,8	8,6
	lux	5.556	3.152	2.000	1.389	1.020	781	617	500	413
	m	6	8	10	12	14	16	18	20	22





COMPATIBLE LAMPS

CP72 GY16 2000W 230V/240V 3200K 480 hrs

LDR recommends Philips lamps

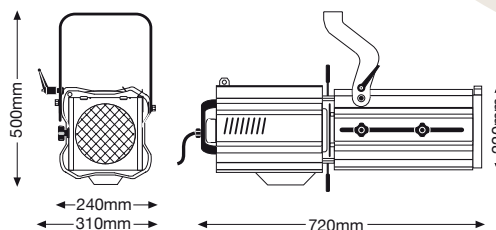

ACCESSORIES

- 20100106 colour frame, black
- 20100706 iris diaphragm
- 20100806 gobo holder, A/B size
- 20100900 hook clamp
- 20101300 safety bond
- 20106019 colour scroller Xpress 19
- 20600006 plate 185x185mm for Xpress 19

PRODUCT SPECS

optical system
double condenser+zoom

reflector
68mm dia. glass

microswitch
double-pole

colour frame
185x185mm

throw
6-23m

beam angle
18°-36°

weight
14 kg

For closer projection in larger venues, this wide-angle 18° - 36° 2000W spotlight incorporates a zoom focus double condenser optical system, rotating gate, a cranked fork and a double microswitch interlock for safe lamp replacement. A colour frame, safety guard, 4 beam shutters and 2m mains cable are also included.

Sagomatore da 2000W ad angolo largo per l'impiego in grandi installazioni che richiedano un'eccezionale qualità ottica. Oltre che di un doppio condensatore ottico dispone di alloggiamento ghigliottine girevole, blocco forcella a leva e doppio microinterruttore. Fornito di serie completo di telaio portagelatina, rete di protezione, 4 ghigliottine sagomatici e 2m cavo di alimentazione.

PHOTOMETRIC DATA CP72

	m Ø	2,5	3,2	3,8	4,4	5,1	5,7	6,3	7,0	7,6
NARROW	lux	4.328	2.770	1.924	1.413	1.082	855	693	572	481
	m	8	10	12	14	16	18	20	22	24
	m Ø	3,9	5,2	6,5	7,8	9,1	10,4	11,7	13,0	14,3
WIDE	lux	5.556	3.152	2000	1389	1020	781	617	500	413
	m	6	8	10	12	14	16	18	20	22

TONO 30/55

10903040 black



COMPATIBLE LAMPS

CP72 GY16 2000W 230V/240V 3200K 480 hrs

LDR recommends Philips lamps

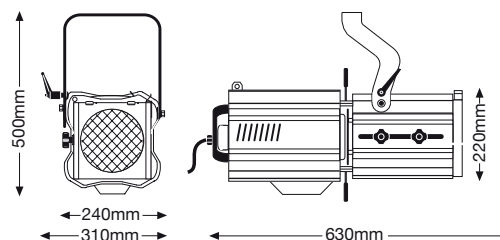

ACCESSORIES

- 20100106 colour frame, black
- 20100706 iris diaphragm
- 20100806 gobo holder, A/B size
- 20100900 hook clamp
- 20101300 safety bond
- 20106019 colour scroller Xpress 19
- 20600006 plate 185x185mm for Xpress 19

PRODUCT SPECS

lens type
double condenser+zoom

reflector
68mm dia. glass

microswitch
double-pole

colour frame
185x185mm

throw
4-12m

beam angle
30°-55°

weight
13,7 kg

Extremely wide-angle 2000W profile spotlight for very close projection in larger venues. It incorporates a zoom focus double condenser optical system, rotating gate, a cranked fork and a double microswitch interlock for safe lamp replacement.

A colour frame, safety guard, 4 beam shutters and 2m mains cable are also included.

Sagomatore da 2000W ad angolo estremamente largo progettato per l'impiego su fronte scena in grandi installazioni che richiedano un'eccezionale qualità ottica.

Dispone di doppio condensatore ottico, alloggiamento ghigliottine girevole, blocco forcella a leva e doppio microinterruttore.

Fornito di serie completo di telaio portagelatina, rete di protezione, 4 ghigliottine sagomatici e 2m cavo di alimentazione.

PHOTOMETRIC DATA CP72

NARROW	m Ø	2,1	2,7	3,2	3,8	4,3	4,8	5,4	5,9	6,4
	lux	6.263	4.008	2.783	2.045	1.566	1.237	1.002	828	696
	m	4	5	6	7	8	9	10	11	12
WIDE	m Ø	4,2	5,2	6,2	7,3	8,3	9,4	10,4	11,5	12,5
	lux	2.406	1.540	1.069	786	602	475	385	318	267
	m	4	5	6	7	8	9	10	11	12



CANTO 250 MSD



10207080 black
K10207080 kit



COMPATIBLE LAMPS

Philips msd 250/2 GY9.5 8500K 3000 hrs

LDR recommends Philips lamps

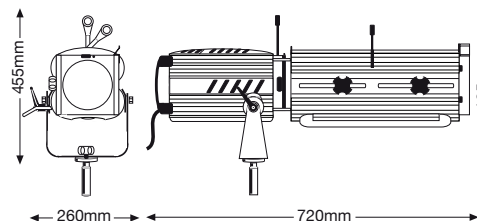

PRODUCT SPECS

optical system
double condenser+zoom

reflector
55 mm dia. glass

microswitch
double-pole

ballast
built-in-PFC

colour frame
150x150 mm

throw
2-15 m

beam angle
10°-28°

voltage
208/230/240V

weight
13,6 kg

ACCESSORIES

20100103	colour frame
20100707	iris diaphragm
20100801	gobo-holder, A/B size
20105103	5-colour-colour-changer
20102200	29 mm dia spigot
20102401	black followspot tripod
20102402	chrome followspot tripod
20106013	colour scroller Xpress 13
20107081	flight case with braking wheels

Canto 250msd is a small, compact yet powerful discharge followspot, the ideal choice for clubs and smaller venues.

It features a double condenser optical system, integral ballast unit with on/off switch and double microswitch interlock for safe lamp replacement. It also includes as standard a colour frame, iris diaphragm, black-out mechanical dimmer, a 29mm diameter spigot for mounting on a stand and 1,5 m mains cable.

A five-colour colour changer unit is available as an optional extra.

Questo piccolo seguipersona da 250W per lampade MSD è la scelta ideale per club, scuole e piccoli ambienti. Dispone di doppio condensatore ottico, ballast incorporato, interruttore on/off e doppio microinterruttore di sicurezza.

Fornito di serie completo di telaio portagelatina, diaframma ad iride, dimmer meccanico, perno per stativo Ø29mm e 1,5m cavo di alimentazione.

E' inoltre disponibile come accessorio un cambia-colori manuale a 5 colori.

PHOTOMETRIC DATA MSD 250/2

	m Ø	0,3	0,5	0,7	0,9	1,0	1,4	1,7	2,1	2,4
SPOT	lux	12.650	5.622	3.163	2.024	1.406	791	506	351	258
	m	2	3	4	5	6	8	10	12	14
	m Ø	1	1,5	2	2,5	3	3,5	4	4,5	5
FLOOD	lux	10.700	4.756	2.675	1.712	1.189	873	669	528	428
	m	2	3	4	5	6	7	8	9	10
	m Ø	1	1,5	2	2,5	3	3,5	4	4,5	5

SPECIALS

CANTO 250 KIT includes/comprende

followspot	seguipersona
colour changer	c. colori
black tripod	stativo nero
MSD 250/2 lamp	lampada MSD 250/2
flight case	flight case

CANTO 250 HR MK2



10257180 black
 10257181 white
 K10257180 kit



COMPATIBLE LAMPS

Philips st 250hr GZY9.5 3200K 4000 hrs

LDR recommends Philips lamps

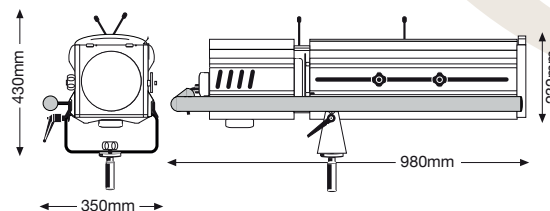

ACCESSORIES

20100106	colour frame
20100707	iris diaphragm
20100708	black-out iris diaphragm
20100807	gobo-holder, A/B size
20105106	5-col. colour changer, black
20105106B	5-col. colour changer, white
20102200	29mm dia spigot
20102401	black followspot tripod
20102402	chrome followspot tripod
20102900	stirrup-kit for suspension
20107180	flight-case with braking wheels, colour changer on
20107070	kit one-hand control iris+dowser

PRODUCT SPECS

lens type	double condenser+zoom
reflector	68mm dia. glass
microswitch	no
ballast	built-in-electronic
colour frame	185x185mm
throw	10-20m
beam angle	8°-22°
voltage	90/265V
weight	19,8 kg / 62,8 kg kit

Canto 250HR is based on the ST250HR ceramic lamp from Philips, which provides 3200°K and a CRI>90 with only a quarter of the power consumption compared with a 1KW halogen lamp. The fan-free cooling system makes it ideal for TV studios and theatre applications. Lamp, iris, mechanical dimmer, spigot, colour frame and 2m mains cable are included as standard, and a 5-colour colour changer is available as an optional extra.

Canto 250HR è un seguipersona innovativo, unico nel suo genere. La lampada Philips ST250HR offre tutti i vantaggi della tecnologia della ceramica applicata ad utilizzi che erano stati fino ad oggi riservati solamente alle alogene. La ventilazione a convezione naturale e quindi la silenziosità di funzionamento lo rendono ideale per utilizzo in studi televisivi ed ambienti teatrali. Canto 250HR viene fornito di serie completo di lampada, telaio portagelatina, diaframma ad iride, dimmer meccanico e perno per stativo. Il cambiacolore è invece un accessorio da ordinare separatamente.

PHOTOMETRIC DATA 250 HR

	m Ø	1,4	1,5	1,7	1,8	2,0	2,1	2,2	2,4	2,5
NARROW	lux	1.954	1.615	1.357	1.156	997	868	763	676	603
	m	10	11	12	13	14	15	16	17	18
WIDE	m Ø	3,1	3,5	3,9	4,3	4,7	5,1	5,4	5,8	6,2
	lux	1.024	809	655	541	455	388	334	291	256
	m	8	9	10	11	12	13	14	15	16

SPECIALS

CANTO 250 HR KIT includes/comprende	
followspot	seguipersona
colour changer on	c.colori montato
black tripod	stativo nero
ST 250 HR lamp	lampada ST 250 HR
flight case	flight case

CANTO 575 msd/msr MK2



10577180	230V black	10577280	250V black
10577181	230V white	10577281	250V white
K10577180	230V kit	K10577280	250V kit
11577180	120V black	11577280	100V black
11577181	120V white	11577281	100V white
K11577180	120V kit	K11577280	100V kit

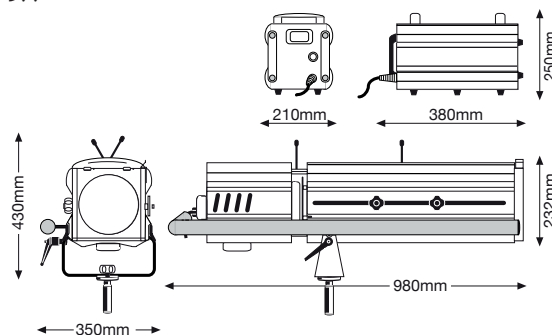

PRODUCT SPECS

optical system
double condenser+zoom

reflector
68mm dia. glass

microswitch
double-pole

ballast
external, PFC

colour frame
185x185mm

throw
10-30m

beam angle
8°-22°

voltage
100/120/230/250V

weight
19,8 kg - ballast 16,5/28 (120V)
79,3 kg - kit 230/250V
90,8 kg - kit 100/120V

COMPATIBLE LAMPS

Philips msr 575/2 GX9.5 7200K 1000 hrs

Philips msr 575 GX9.5 6000K 3000 hrs

LDR recommends Philips lamps

ACCESSORIES

20100106	colour frame
20100707	iris diaphragm
20100708	black-out iris diaphragm
20100807	gobo-holder, A/B size
20105106	5-col. colour changer, black
20105106B	5-col. colour changer, white
20102200	29mm dia spigot
20102401	black followspot tripod
20102402	chrome followspot tripod
20102900	stirrup-kit for suspension
20107180	flight-case with braking wheels, colour changer on
20107070	kit one-hand control iris+dowser
20109106	kit colour frame + front runners Canto kit

Medium-throw discharge followspot for either MSD or MSR lamp. It features a large, user-friendly side handle, strong mechanics and excellent optics. Standard delivery includes an external ballast, iris, mechanical dimmer, spigot, colour frame and 2m mains cable.

Seguipersona a doppio condensatore ottico per lampade a scarica 575 MSD o MSR. Eccellente resa ottica per uso sulle medie distanze. Viene fornito di serie completo di unità ballast esterna, diaframma ad iride, dimmer meccanico, perno per stativo, telaio porta-gelatina e 2m cavo di alimentazione.

PHOTOMETRIC DATA 575 MSR

NARROW	m Ø	1,5	1,7	1,9	2,1	2,3	2,5	2,7	2,9	3,1
	lux	2.908	2.227	1.759	1.425	1.178	990	843	727	633
	m	14	16	18	20	22	24	26	28	30
WIDE	m Ø	2,6	3,2	3,7	4,2	4,7	5,3	5,8	6,3	6,8
	lux	1.363	946	695	532	421	341	282	237	202
	m	10	12	14	16	18	20	22	24	26

SPECIALS

CANTO 575 KIT includes/comprende

followspot	seguipersona
colour changer on	c. colori montato
black tripod	stativo nero
MSR 575/2 lamp	lampada MSR 575/2
flight case	flight case

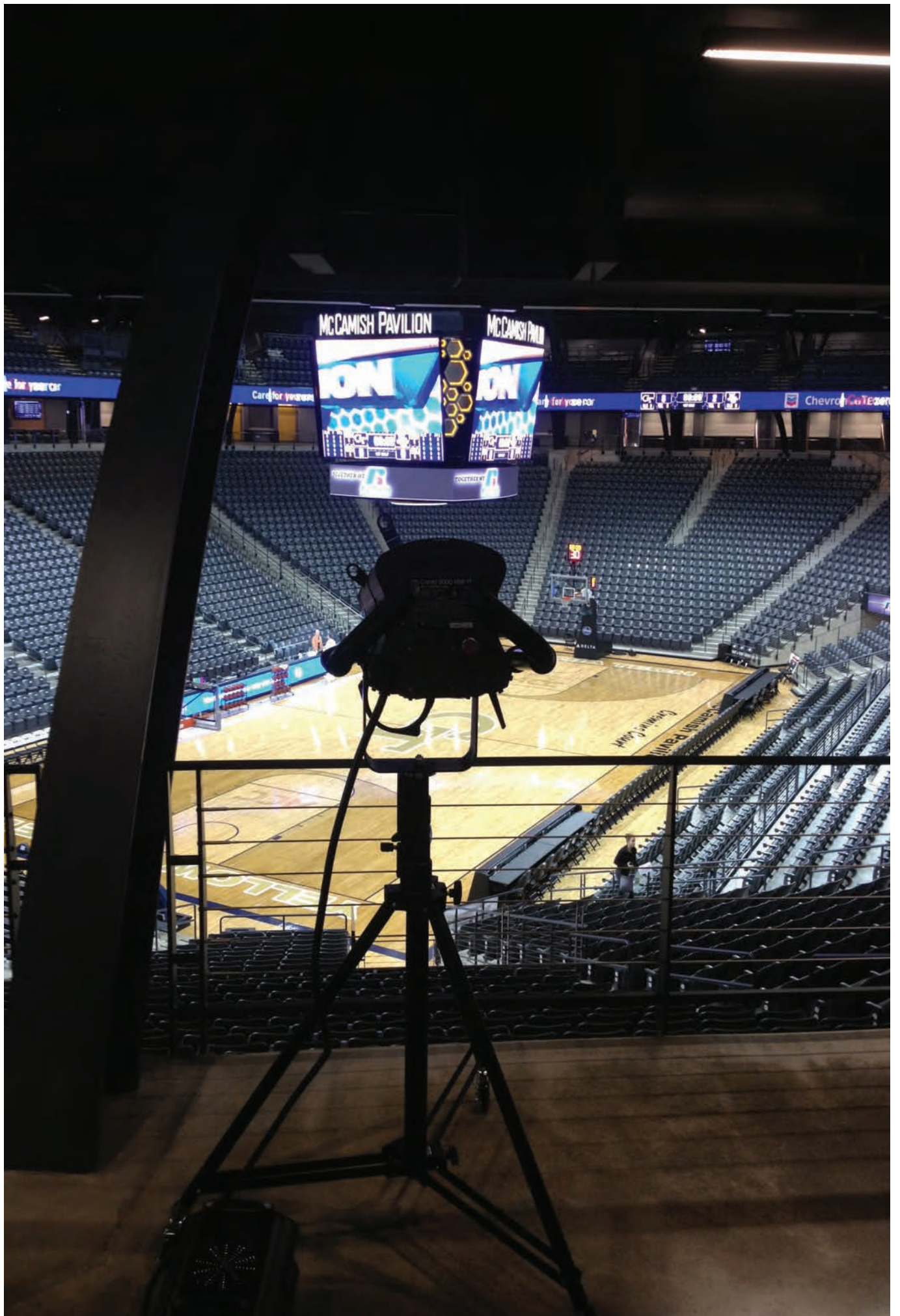

CANTO 700 msd/msr MK2



10707180	230V black	10707280	250V black
10707181	230V white	10707281	250V white
K10707180	230V kit	K10707280	250V kit
11707180	120V black		
11707181	120V white		
K11707180	120V kit		

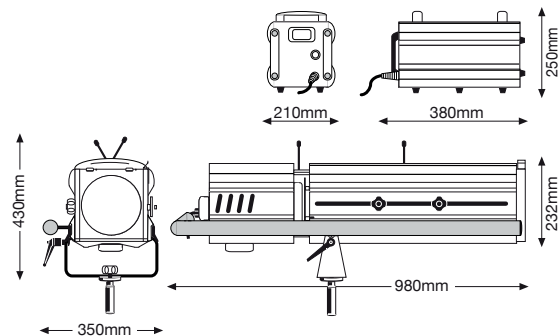

PRODUCT SPECS

optical system
double condenser+zoom

reflector
68mm dia. glass

microswitch
double-pole

ballast
external, PFC

colour frame
185x185mm

throw
10-35m

beam angle
8°-22°

voltage
120V/230V/250V

weight
19,8 kg - ballast 16,5/28 (120V)
79,3 kg - kit 230/250V
90,8 kg - kit 120V

COMPATIBLE LAMPS

Philips msr 700/2 G22 7200K 1000 hrs

Philips msr 700 G22 6000K 3000 hrs

LDR recommends Philips lamps

ACCESSORIES

20100106	colour frame
20100707	iris diaphragm
20100708	black-out iris diaphragm
20100807	gobo-holder, A/B size
20105106	5-col. colour changer, black
20105106B	5-col. colour changer, white
20102200	29mm dia spigot
20102401	black followspot tripod
20102402	chrome followspot tripod
20102900	stirrup-kit for suspension
20107180	flight-case with braking wheels, colour changer on
20107070	kit one-hand control iris+dowser
20109106	kit colour frame + front runners Canto kit

For more power at middle-distance throw this 700W MSD or MSR-powered discharge followspot is the obvious choice. It features a large, user-friendly side handle, strong mechanics and excellent optics.

Standard delivery includes an external ballast, iris, mechanical dimmer, spigot, colour frame and 2m mains cable.

Seguipersona a doppio condensatore ottico per lampade a scarica 700 MSD o MSR.

Eccellente resa ottica per uso intenso su medie distanze. Viene fornito di serie completo di unità ballast esterna, diaframma ad iride, dimmer meccanico, perno per stativo, telaio porta-gelatina e 2m cavo di alimentazione.

PHOTOMETRIC DATA 700 MSD

NARROW	m Ø	1,9	2,1	2,3	2,5	2,7	2,9	3,1	3,3	3,6
	lux	3.507	2.841	2.348	1.973	1.681	1.449	1.263	1.110	983
	m	18	20	22	24	26	28	30	32	34
WIDE	m Ø	2,6	3,2	3,7	4,2	4,7	5,3	5,8	6,3	6,8
	lux	2.727	1.894	1.391	1.065	842	682	563	473	403
	m	10	12	14	16	18	20	22	24	26

SPECIALS

CANTO 700 KIT includes/comprende

followspot	seguipersona
colour changer on	c. colori montato
black tripod	stativo nero
MSR 700/2 lamp	lampada MSR 700/2
flight case	flight case

CANTO 1200 msd/msr MK2



10857180	230V	black	10857280	250V	black
10857181	230V	white	10857281	250V	white
K10857180	230V	kit	K10857280	250V	kit
11857180	120V	black	11857280	100V	black
11857181	120V	white	11857281	100V	white
K11857180	120V	kit	K11857280	100V	kit

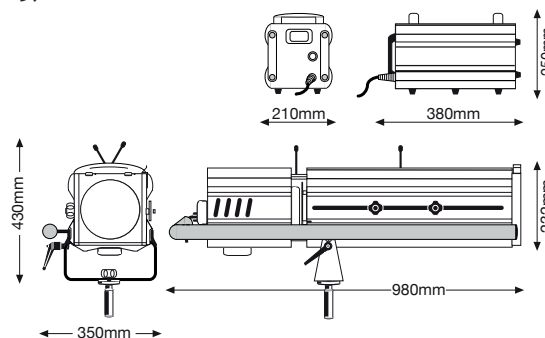

The most popular in the range, Canto 1200 MSD/MSR produces a well-defined, flat-field projection, ideal for use in medium-large-scale venues. It features a large, user-friendly side handle, strong mechanics and excellent optics. Standard delivery includes an external ballast, iris, mechanical dimmer, spigot, colour frame and 2m mains cable.

Il best-seller della gamma, Canto 1200 MSD/MSR produce un fascio di luce estremamente preciso, che lo rende perfetto per uso in proiezioni sulla media-lunga distanza.

Viene fornito di serie completo di unità ballast esterna, diaframma ad iride, dimmer meccanico, perno per stativo, telaio porta-gelatina e 2m cavo di alimentazione.

PRODUCT SPECS

lens type
double condenser+zoom

reflector
68mm dia. glass

microswitch
double-pole

ballast
external, PFC

colour frame
185x185mm

throw
10-40m

beam angle
8°-22°

voltage
100V/120V/230V/250V

weight
19,8 kg - ballast 16,5/28 (120V)
81,6 kg - kit 230/250V
90,8 kg - kit 100V

COMPATIBLE LAMPS

Philips msr 1200 G22 5900K 800 hrs

Philips msr 1200/2 G22 7200K 800 hrs

Philips msd 1200 G22 6000K 3000 hrs

LDR recommends Philips lamps

ACCESSORIES

20100106	colour frame
20100707	iris diaphragm
20100708	black-out iris diaphragm
20100807	gobo-holder, A/B size
20105106	5-col. colour changer, black
20105106B	5-col. colour changer, white
20102200	29mm dia spigot
20102401	black followspot tripod
20102402	chrome followspot tripod
20102900	stirrup-kit for suspension
20107180	flight-case with braking wheels, colour changer on
20107070	kit one-hand control iris+dowser
20109106	kit colour frame + front runners Canto kit

SPECIALS

CANTO 1200 KIT includes/comprende

followspot	seguipersona
colour changer on	c. colori montato
black tripod	stativo nero
MSR 1200 lamp	lampada MSR 1200
flight case	flight case

PHOTOMETRIC DATA 1200 MSD

NARROW	m Ø	2,5	2,7	2,9	3,1	3,3	3,6	3,8	4,0	4,2
	lux	3.863	3.291	2.838	2.472	2.173	1.925	1.717	1.541	1.391
	m	24	26	28	30	32	34	36	38	40
WIDE	m Ø	2,6	3,7	3,7	4,2	4,7	5,3	5,8	6,3	6,8
	lux	5.563	3.863	2.838	2.173	1.717	1.391	1.149	966	823
	m	10	12	14	16	18	20	22	24	26

CANTO 1500 msr FF



10867180 230V black
K10867180 230V kit

11867180 120V black
K11867180 120V kit



COMPATIBLE LAMPS

Philips 1500msr 1500W 6000K 750 hrs

Gold Fast Fit PGJx50

LDR recommends Philips lamps

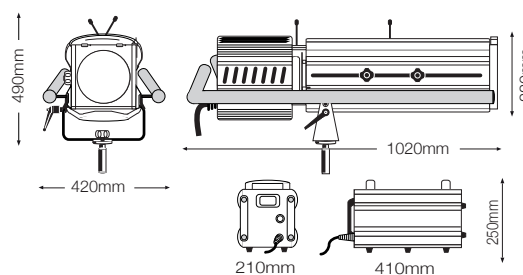

New concept, efficient, lightweight and extremely powerful 1500W discharge followspot, for more power at middle, long distance throw. The Msr filling of the lamp guarantees pure, white light, whereas the short arc provides high beam intensity for professional entertainment lighting.

Canto 1500msr FF features an electronic, flicker free ballast and standard delivery includes two large side handles, iris, mechanical dimmer, spigot, colour frame and 2m mains cable.

Seguipersona a scarica da 1500W, estremamente compatto e potente, ideale per quegli utilizzi sulla media-lunga distanza dove sia richiesta una resa luce particolarmente intensa.

La lampada MSR garantisce una luce bianca e pura, mentre l'arco corto produce un elevato flusso luminoso ed un'ottima resa cromatica, che consentono di soddisfare qualsiasi esigenza nell'ambito dell'illuminazione spettacolare professionale.

Canto 1500msr FF dispone di un ballast elettronico flicker-free e la dotazione standard comprende due ampie maniglie laterali per il brandeggio, diaframma e iride, dimmer meccanico, perno per stativo e 2m cavo di alimentazione.

PRODUCT SPECS

optical system
double condenser+zoom

reflector
87,5mm dia. glass

ballast
electronic, flicker-free ballast

colour frame
185x185mm

throw
10-45m

beam angle
8°-22°

weight
22,0 kg - 8,5 kg ballast
70,0 kg - kit

ACCESSORIES

- 20100106 colour frame
- 20100707 iris diaphragm
- 20100708 black-out iris diaphragm
- 20100807 gobo-holder, A/B size
- 20105106 5-col. colour changer, black
- 20102200 29mm dia spigot
- 20102401 black followspot tripod
- 20102402 chrome followspot tripod
- 20102900 stirrup-kit for suspension
- 20107180 flight-case with braking wheels, colour changer on
- 20107070 kit one-hand control iris+dowser
- 20109106 kit colour frame + front runners Canto kit

PHOTOMETRIC DATA PHILIPS MSR GOLD1500 FASTFIT

	m Ø	2,5	2,7	2,9	3,1	3,3	3,6	3,8	4,0	4,2
NARROW	lux	4.048	3.449	2.974	2.591	2.277	2.017	1.799	1.615	1.457
	m	24	26	28	30	32	34	36	38	40
WIDE	m Ø	3,2	3,7	4,2	4,7	5,3	5,8	6,3	6,8	7,4
	lux	4.153	3.051	2.336	1.846	1.495	1.236	1.038	885	763
	m	12	14	16	18	20	22	24	26	28

SPECIALS

CANTO 1500 KIT includes/comprende	
followspot	seguipersona
colour changer on	c. colori montato
black tripod	stativo nero
MSR 1500 Gold lamp	lampada MSR 1500 Gold
flight case	flight case

CANTO 2000 msr FF



10907180 black
K10907181 kit



COMPATIBLE LAMPS

Philips 2000 msr/2	2000W	7500K	750 hrs
Gold/2 FastFit PGJx50			
Philips 2000 msr	2000W	6000K	750 hrs
Gold/2 FastFit PGJx50			

LDR recommends Philips lamps

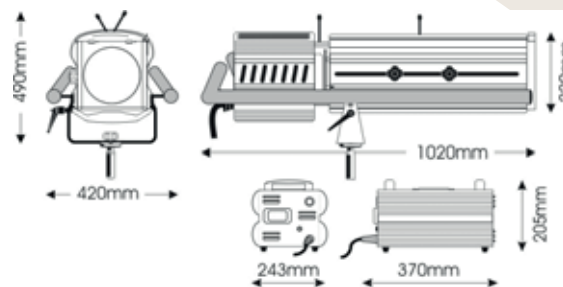

PRODUCT SPECS

optical system
double condenser+zoom

reflector
68mm dia. glass

ballast
electronic, flicker-free ballast

colour frame
185x185mm

throw
10-50m

beam angle
8°-22°

voltage
180V/265V

lamp base
PGJx50

weight
22,0 kg - 8,5 kg ballast
70,0 kg - kit

The Canto 2000msr FF is an efficient, lightweight and extremely powerful 2K discharge followspot, ideal for all long-throw applications. It features the patented FastFit rear load lamp base system, which enables an easy lamp replacement in difficult stage conditions. Standard delivery includes iris, mechanical dimmer, spigot, colour frame and 2m mains cable.

Canto 2000msr FF è un seguipersona a scarica estremamente compatto e potente. Ha una resa ottica strabiliante, che lo rende lo strumento ideale per tutti gli utilizzi su lunghe distanze.

Utilizza la tecnologia FastFit, portalampada ad innesto rapido, che consente una semplice sostituzione della lampada anche in condizioni estreme. Fornito di serie completo di diaframma ad iride, dimmer meccanico, perno per stativo, telaio portagelatina e 2m cavo di alimentazione.

ACCESSORIES

20100106	colour frame
20100707	iris diaphragm
20100807	gobo-holder, A/B size
20105106	5-col. colour changer, black
20102200	29mm dia spigot
20102401	black followspot tripod
20102402	chrome followspot tripod
20102900	stirrup-kit for suspension
20107180	flight-case with braking wheels, colour changer on
20107070	kit one-hand control iris+dowser
20109106	kit colour frame + front runners Canto kit

PHOTOMETRIC DATA 2000/2 GOLD

	m Ø	2,5	2,7	2,9	3,1	3,3	3,6	3,8	4,0	4,2
NARROW	lux	4.681	3.988	3.439	2.996	2.633	2.332	2.080	1867	1.685
	m	24	26	28	30	32	34	36	38	40
WIDE	m Ø	3,2	3,7	4,2	4,7	5,3	5,8	6,3	6,8	7,4
	lux	5.100	3.747	2.869	2.267	1.836	1.517	1.275	1.086	937
	m	12	14	16	18	20	22	24	26	28

SPECIALS

CANTO 2000msr KIT includes/comprende	
followspot	seguipersona
colour changer on	c, colori montato
black tripod	stativo nero
MSR 2000	MSR 2000
Gold/2 FastFit	Gold/2 FastFit
flight case	flight case

CANTO 1200 TH MK2



10857170	230V black	11857170	120V black
10857171	230V white	11857171	120V white
K10857170	230V kit	K11857170	120V kit



COMPATIBLE LAMPS

CP90	GX9.5	1200W	230V/240V	3200K	240 hrs
T29	GX9.5	1200W	230V/240V	3000K	480 hrs
EGT	G22	1000W	120V	3200K	300 hrs

LDR recommends Philips lamps

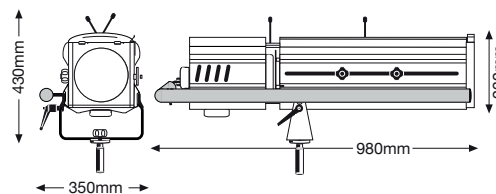

ACCESSORIES

20100106	colour frame
20100707	iris diaphragm
20100708	black-out iris diaphragm
20100807	gobo-holder, A/B size
20105106	5-col. colour changer, black
20105106B	5-col. colour changer, white
20102200	29mm dia spigot
20102401	black followspot tripod
20102402	chrome followspot tripod
20102900	stirrup-kit for suspension
20107180	flight-case with braking wheels, colour changer on
20107070	kit one-hand control iris+dowser
20109106	kit colour frame + front runners Canto kit

PRODUCT SPECS

optical system	double condenser+zoom
reflector	68mm dia. glass
microswitch	double
colour frame	185x185mm
throw	10-20m
beam angle	8°-22°
lamp base	GX9.5 (230V) - G22 (120V)
weight	19,8 kg - 62,8 kg kit

Compact, short to medium - throw 1200W tungsten halogen followspot. It features a large, user-friendly side handle, strong mechanics and excellent optics.

Standard delivery includes iris, mechanical dimmer, spigot, colour frame and 2m mains cable.

Seguipersona a doppio condensatore ottico per lampade alogene da 1200W, ideale sulla breve-media distanza.

Viene fornito di serie completo di diaframma ad iride, dimmer meccanico, perno per stativo telaio porta-gelatina e 2m cavo di alimentazione.

PHOTOMETRIC DATA CP90

	m Ø	1,7	1,8	2	2,1	2,2	2,4	2,5	2,7	2,8
NARROW	lux	2.118	1.805	1.556	1.356	1.191	1.055	941	845	763
	m	12	13	14	15	16	17	18	19	20
WIDE	m Ø	3,9	4,3	4,7	5,1	5,4	5,8	6,2	6,6	7
	lux	1.540	1.273	1.069	911	786	684	602	533	475
	m	10	11	12	13	14	15	16	17	18

SPECIALS

CANTO 1200 TH KIT includes/comprende	
followspot	seguipersona
colour changer on	c. colori montato
black tripod	stativo nero
CP90/EGT lamp	lampada CP90/EGT
flight case	flight case



CANTO 2000 TH MK2



10907170	230V black	11907170	120V black
10907171	230V white	11907171	120V white
K10907170	230V kit	K11907170	120V kit



COMPATIBLE LAMPS

CP72	GY16	2000W	230V/240V	3200K	480 hrs
CP79	GY16	2000W	120V	3200K	350 hrs

LDR recommends Philips lamps

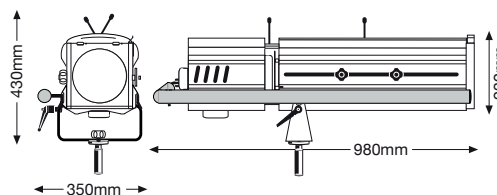

PRODUCT SPECS

optical system
double condenser+zoom

reflector
68mm dia. glass

microswitch
double-pole

colour frame
185x185mm

throw
10-30m

beam angle
8°-22°

lamp base
230V and 120V

weight
19,8 kg - 62,8 kg kit

ACCESSORIES

20100106	colour frame
20100707	iris diaphragm
20100807	gobo-holder, A/B size
20105106	5-col. colour changer, black
20105106B	5-col. colour changer, white
20102200	29mm dia spigot
20102401	black followspot tripod
20102402	chrome followspot tripod
20102900	stirrup-kit for suspension
20107180	flight-case with braking wheels, colour changer on
20107070	kit one-hand control iris+dowser
20109106	kit colour frame + front runners Canto kit

The most powerful dimmable tungsten halogen followspot in the range, Canto 2000TH is the professionals' choice for applications in large venues.

It features a large, user-friendly side handle, strong mechanics and excellent optics. Standard delivery includes iris, mechanical dimmer, spigot, colour frame and 2m mains cable.

Seguipersona a doppio condensatore ottico per lampade alogene da 2000W, è la scelta ideale per utilizzi professionali su lunghe distanze. Viene fornito di serie completo di diaframma ad iride, dimmer meccanico, perno per stativo telaio porta-gelatina e 2m cavo di alimentazione.

PHOTOMETRIC DATA CP72

	m Ø	2,0	2,2	2,5	2,8	3,1	3,4	3,6	3,9	4,2
NARROW	lux	2.443	1.870	1.478	1.197	989	831	708	611	532
	m	14	16	18	20	22	24	26	28	30
WIDE	m Ø	3,9	4,7	5,4	6,2	7,0	7,8	8,6	9,3	10,1
	lux	2.000	1.389	1.020	781	617	500	413	347	296
	m	10	12	14	16	18	20	22	24	26

SPECIALS

CANTO 2000 TH KIT includes/comprende	
followspot	seguipersona
colour changer on	c. colori montato
black tripod	stativo nero
CP72 lamp	lampada CP72
flight case	flight case

SCENA 500

10305060 black



ACCESSORIES

- 20100109 colour frame, black
- 20100409 4-leaf barndoor
- 20100900 hook clamp
- 20101300 safety bond

COMPATIBLE LAMPS

- 160W** Plusline ES Small R7s 230V 3100lm 2000hrs
- 240W** Plusline ES Small R7s 230V 4900lm 2000hrs
- 400W** Plusline ES Small R7s 230V 8700lm 360hrs

LDR recommends Philips lamps

PHOTOMETRIC DATA K1

HORIZONTAL	m Ø						
	3,2	4,9	6,5	8,1	9,7	11,3	
lux	913	406	228	146	101	74	
m	2	3	4	5	6	7	
VERTICAL	m Ø						
	1,9	2,9	3,8	4,8	5,7	6,7	
lux	1.345	598	336	215	149	110	
m	2	3	4	5	6	7	

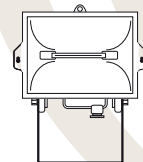

←180mm→

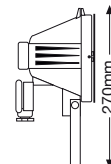

↑270mm

←135mm→



SCENA 1000

10805060 black



ACCESSORIES

- 20100108 colour frame, black
- 20100408 4-leaf barndoor
- 20100900 hook clamp
- 20101300 safety bond

PRODUCT SPECS

reflector
aluminium, symmetrical

microswitch
no

colour frame
180x148mm / 345x210mm

throw
2-5m / 2-10m

ip
54

weight
1,3kg / 3,3kg

Small, die-cast body 300/500W and 1000/1250W symmetrical floodlight, suitable also for usage outdoors (IP54). It features a simple but effective accessory holder system which gives the product the flexibility of using either a colour filter or a coloured glass. The colour frame is included in standard delivery.

Diffusore simmetrico da 300/500W e 1000/1250W dalla scocca in alluminio pressofuso ed adatto anche per uso in esterni (IP54). E' dotato di sportello anteriore basculante e di un semplice ma efficace sistema di fissaggio degli accessori. Fornito di serie completo di telaio porta-gelatina e vetro di sicurezza. Cavo di alimentazione non compreso.

COMPATIBLE LAMPS

- P2/10** R7s 625W 230V/240V 3200K 150hrs
- P2/7** R7s 1000W 230V/240V 3200K 200hrs
- P2/12** R7s 1250W 230V/240V 3200K 200hrs

LDR recommends Philips lamps

PHOTOMETRIC DATA P2/7

HORIZONTAL	m Ø									
	3,7	5,9	7,5	9,9	11,8	13,8	15,8	17,7	19,7	
lux	4.625	2.056	1.156	740	514	378	289	228	182	
m	2	3	4	5	6	7	8	9	10	
VERTICAL	m Ø									
	4,1	6,1	8,1	10,2	14,2	16,3	18,3	20,3	22,4	
lux	4.900	2.178	1.225	784	544	400	306	242	196	
m	2	3	4	5	6	7	8	9	10	

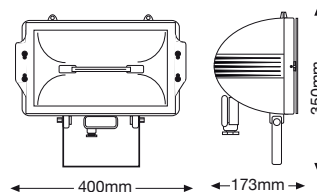

←400mm→

←173mm→

↑350mm

RIMA A 500



with stirrup con forcella	10506050 black	without stirrup senza forcella	10506150 black
	10506051 white		10506151 white
	10506052 silver		10506152 silver



COMPATIBLE LAMPS

160W	Plusline ES Small R7s 230V	3100lm	2000 hrs
240W	Plusline ES Small R7s 230V	4900lm	2000 hrs
400W	Plusline ES Small R7s 230V	8700lm	360 hrs

LDR recommends Philips lamps

Available to special order with extended front chassis for longer gel life.

Su richiesta disponibile anche con telaio anteriore esteso per gelatine dai colori saturi.

Stylish and high specification 500W asymmetrical floodlights, ideal for professional usage in all cyclorama-type lighting applications.

Rima A500F is designed for usage as single module flood, but a large choice of different models and accessories is available for the creation of multiple rows or square-battens.

Rima A500 is delivered complete with colour frame and 1,5m mains cable.

Diffusore asimmetrico da 500W, di linea gradevole e di elevata resa ottica.

E' la scelta ideale per l'illuminazione omogenea di fondali e parti di scena da angolature oblique, anche in ambito professionale. Rima A500F è la versione a modulo singolo, ma è disponibile un'ampia scelta di altri modelli ed accessori per il montaggio modulare. Viene fornito di serie completo di telaio porta-gelatina e 1,5m cavo di alimentazione.

PRODUCT SPECS

reflector
aluminium, asymmetrical

microswitch
no

colour frame
244x195mm

throw
2-5m

weight
2,0kg

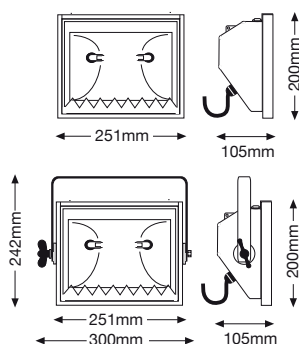

ACCESSORIES

20100120	colour frame, black
20100120B	colour frame, white
20100120C	colour frame, silver
20100220	safety guard, black
20100420	4-leaf barndoor, black
20100420B	4-leaf barndoor, white
20100420C	4-leaf barndoor, silver
20100420D	4-leaf barndoor, white/black
20100420E	4-leaf barndoor, silver/black
20100520	2-leaf barndoor, black
20100520B	2-leaf barndoor, white
20100520C	2-leaf barndoor, silver
20100520D	2-leaf barndoor, white/black
20100520E	2-leaf barndoor, silver/black
20100620	3-leaf barndoor, black
20100620B	3-leaf barndoor, white
20100620C	3-leaf barndoor, silver
20100620D	3-leaf barndoor, white/black
20100620E	3-leaf barndoor, silver/black
20101420	safety glass
20101920	kit for square mounting
20102621	stirrup kit 1 Rima
20102622	kit for linear mounting 2 Rima
20102623	kit for linear mounting 3 Rima
20102624	kit for linear mounting 4 Rima
20100900	hook clamp
20101300	safety bond

PHOTOMETRIC DATA K1

HORIZONTAL	m Ø	3,1	4,7	6,3	7,8	9,4	10,9	12,5	14,1	15,6
	lux	1.585	704	396	254	176	129	99	78	63
m	2	3	4	5	6	7	8	9	10	
VERTICAL	m Ø	1,9	2,9	3,8	4,8	5,7	6,7	7,6	8,6	9,5
	lux	2.151	956	538	344	239	176	134	106	86
m	2	3	4	5	6	7	8	9	10	

RIMA A 500 PRO



with stirrup con forcella	10516050 black	without stirrup senza forcella	10516150 black
	10516051 white		10516151 white
	10516052 silver		10516152 silver



COMPATIBLE LAMPS

160W	Plusline ES Small R7s 230V	3100lm	2000 hrs
240W	Plusline ES Small R7s 230V	4900lm	2000 hrs
400W	Plusline ES Small R7s 230V	8700lm	360 hrs

LDR recommends Philips lamps

Available to special order with extended front chassis for longer gel life.

Su richiesta disponibile anche con telaio anteriore esteso per gelatine dai colori saturi.

Stylish and high specification 500W asymmetrical floodlights, ideal for professional usage in all cyclorama-type lighting applications. Rima A500F Pro is designed for usage as single module flood, but a large choice of different models and accessories is available for the creation of multiple rows or square-battens.

Rima A500F Pro is delivered complete with colour frame, single microswitch interlock for safe lamp replacement, safety glass and 1,5m mains cable.

Diffusore asimmetrico da 500W, di linea gradevole e di elevata resa ottica. E' la scelta ideale per l'illuminazione omogenea di fondali e parti di scena da angolature oblique, anche in ambito professionale.

Versione per utilizzo a modulo singolo. Si vedano gli altri modelli ed accessori per l'assemblaggio modulare. Viene fornito di serie completo di telaio portagelatina, microinterruttore, vetro di protezione e 1,5m cavo di alimentazione.

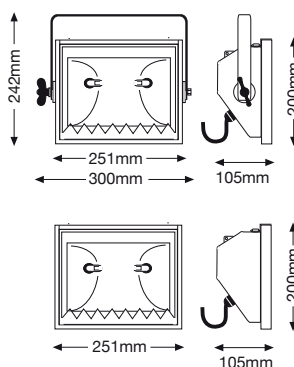

PRODUCT SPECS

reflector
aluminium, asymmetrical

microswitch
single pole

colour frame
244x195mm

throw
2-5m

weight
2,6kg

ACCESSORIES

20100120	colour frame, black
20100120B	colour frame, white
20100120C	colour frame, silver
20100220	safety guard, black
20100420	4-leaf barndoor, black
20100420B	4-leaf barndoor, white
20100420C	4-leaf barndoor, silver
20100420D	4-leaf barndoor, white/black
20100420E	4-leaf barndoor, silver/black
20100520	2-leaf barndoor, black
20100520B	2-leaf barndoor, white
20100520C	2-leaf barndoor, silver
20100520D	2-leaf barndoor, white/black
20100520E	2-leaf barndoor, silver/black
20100620	3-leaf barndoor, black
20100620B	3-leaf barndoor, white
20100620C	3-leaf barndoor, silver
20100620D	3-leaf barndoor, white/black
20100620E	3-leaf barndoor, silver/black
20101420	safety glass
20101920	kit for square mounting
20102621	stirrup kit 1 Rima
20102622	kit for linear mounting 2 Rima
20102623	kit for linear mounting 3 Rima
20102624	kit for linear mounting 4 Rima
20100900	hook clamp
20101300	safety bond

PHOTOMETRIC DATA K1

HORIZONTAL	m Ø	3,1	4,7	6,3	7,8	9,4	10,9	12,5	14,1	15,6
	lux	1.585	704	396	254	176	129	99	78	63
	m	2	3	4	5	6	7	8	9	10
VERTICAL	m Ø	1,9	2,9	3,8	4,8	5,7	6,7	7,6	8,6	9,5
	lux	2.151	956	538	344	239	176	134	106	86
	m	2	3	4	5	6	7	8	9	10

RIMA S 500



with stirrup con forcella	10506060 black	without stirrup senza forcella	10506160 black
	10506061 white		10506161 white
	10506062 silver		10506162 silver



COMPATIBLE LAMPS

160W	Plusline ES Small R7s 230V	3100lm	2000hrs
240W	Plusline ES Small R7s 230V	4900lm	2000hrs
400W	Plusline ES Small R7s 230V	8700lm	360hrs

LDR recommends Philips lamps

Available to special order with extended front chassis for longer gel life.

Su richiesta disponibile anche con telaio anteriore esteso per gelatine dai colori saturi.

ACCESSORIES

20100121	colour frame, black
20100121B	colour frame, white
20100121C	colour frame, silver
20100220	safety guard, black
20100420	4-leaf barndoor, black
20100420B	4-leaf barndoor, white
20100420C	4-leaf barndoor, silver
20100420D	4-leaf barndoor, white/black
20100420E	4-leaf barndoor, silver/black
20100520	2-leaf barndoor, black
20100520B	2-leaf barndoor, white
20100520C	2-leaf barndoor, silver
20100520D	2-leaf barndoor, white/black
20100520E	2-leaf barndoor, silver/black
20100620	3-leaf barndoor, black
20100620B	3-leaf barndoor, white
20100620C	3-leaf barndoor, silver
20100620D	3-leaf barndoor, white/black
20100620E	3-leaf barndoor, silver/black
20101420	safety glass
20101920	kit for square mounting
20102621	stirrup kit 1 Rima
20102622	kit for linear mounting 2 Rima
20102623	kit for linear mounting 3 Rima
20102624	kit for linear mounting 4 Rima
20100900	hook clamp
20101300	safety bond

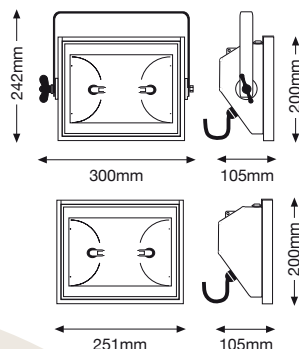

PRODUCT SPECS

reflector
aluminium, symmetrical

microswitch
no

colour frame
244x195mm

throw
2-5m

weight
2,0kg

Stylish and high specification 500W symmetric floodlights, ideal for all applications where a wide, even wash of light is required.

Rima S500F is designed for usage as single module flood, and is delivered complete with colour frame and 1,5m mains cable.

Diffusore simmetrico da 500W, di linea gradevole e di elevata resa ottica.

E' la scelta ideale per l'illuminazione omogenea in diffusione, anche in ambito professionale. Rima S500F è la versione a modulo singolo, ma è disponibile un'ampia scelta di altri modelli ed accessori per il montaggio modulare. Viene fornito di serie completo di telaio porta-gelatina e 1,5m cavo di alimentazione.

PHOTOMETRIC DATA K1

		3,2	4,9	6,5	8,1	9,7	11,3	13	14,6	16,2
HORIZONTAL	m Ø	3,2	4,9	6,5	8,1	9,7	11,3	13	14,6	16,2
	lux	913	406	228	146	101	74	57	45	37
	m	2	3	4	5	6	7	8	9	10
VERTICAL	m Ø	1,9	2,9	3,8	4,8	5,7	6,7	7,6	8,6	9,5
	lux	1.345	598	336	215	149	110	84	66	54
	m	2	3	4	5	6	7	8	9	10

RIMA S 500 PRO



with stirrup con forcella	10516060 black	without stirrup senza forcella	10516160 black
	10516061 white		10516161 white
	10516062 silver		10516162 silver



COMPATIBLE LAMPS

160W Plusline ES Small R7s 230V 3100lm 2000hrs

240W Plusline ES Small R7s 230V 4900lm 2000hrs

400W Plusline ES Small R7s 230V 8700lm 360hrs

LDR recommends Philips lamps

Available to special order with extended front chassis for longer gel life.

Su richiesta disponibile anche con telaio anteriore esteso per gelatine dai colori saturi.

Stylish and high specification 500W symmetric floodlights, ideal for all applications where a wide, even wash of light is required.

Rima S500F Pro is designed for usage as single module flood, and is delivered complete with colour frame, single microswitch interlock for safe lamp replacement, safety glass and 1,5m mains cable, whereas a large choice of accessories is available as optional extras.

Diffusore simmetrico da 500W, di linea gradevole e di elevata resa ottica.

E' la scelta ideale per l'illuminazione omogenea in diffusione, anche in ambito professionale.

Rima S500F Pro è la versione a modulo singolo, ma è disponibile un'ampia scelta di altri modelli ed accessori per il montaggio modulare. Viene fornito di serie completo di telaio portagelatina, microinterruttore di sicurezza, vetro di protezione e 1,5m cavo di alimentazione.

ACCESSORIES

- 20100121 colour frame, black
- 20100121B colour frame, white
- 20100121C colour frame, silver
- 20100220 safety guard, black
- 20100420 4-leaf barndoor, black
- 20100420B 4-leaf barndoor, white
- 20100420C 4-leaf barndoor, silver
- 20100420D 4-leaf barndoor, white/black
- 20100420E 4-leaf barndoor, silver/black
- 20100520 2-leaf barndoor, black
- 20100520B 2-leaf barndoor, white
- 20100520C 2-leaf barndoor, silver
- 20100520D 2-leaf barndoor, white/black
- 20100520E 2-leaf barndoor, silver/black
- 20100620 3-leaf barndoor, black
- 20100620B 3-leaf barndoor, white
- 20100620C 3-leaf barndoor, silver
- 20100620D 3-leaf barndoor, white/black
- 20100620E 3-leaf barndoor, silver/black
- 20101420 safety glass
- 20101920 kit for square mounting
- 20102621 stirrup kit 1 Rima
- 20102622 kit for linear mounting 2 Rima
- 20102623 kit for linear mounting 3 Rima
- 20102624 kit for linear mounting 4 Rima
- 20100900 hook clamp
- 20101300 safety bond

PRODUCT SPECS

reflector
aluminium, symmetrical

microswitch
single pole

colour frame
244x195mm

throw
2-5m

weight
2,6kg

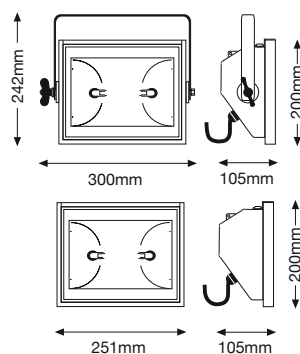

PHOTOMETRIC DATA K1

HORIZONTAL	m Ø	3,2	4,9	6,5	8,1	9,7	11,3	13	14,6	16,2
	lux	913	406	228	146	101	74	57	45	37
m	2	3	4	5	6	7	8	9	10	
VERTICAL	m Ø	1,9	2,9	3,8	4,8	5,7	6,7	7,6	8,6	9,5
	lux	1.345	598	336	215	149	110	84	66	54
m	2	3	4	5	6	7	8	9	10	

10806050 black
 10806051 white
 10806052 silver



COMPATIBLE LAMPS

P2/10 R7s 625W 230V/240V 3200K 150hrs

P2/7 R7s 1000W 230V/240V 3200K 200hrs

P2/12 R7s 1250W 230V/240V 3200K 200hrs

LDR recommends Philips lamps

Available to special order with extended front chassis for longer gel life.

Su richiesta disponibile anche con telaio anteriore esteso per gelatine dai colori saturi.

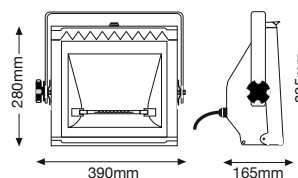

PRODUCT SPECS

reflector

aluminium, asymmetrical

microswitch

double-pole

colour frame

290x270mm

throw

2-10m

weight

5,3kg

This asymmetric 1Kw floodlight evenly illuminates a backcloth, cyclorama or scenic pieces from an oblique angle in larger venues.

Each unit has a hinged front access door and a double-microswitch interlock for safe lamp replacement. The modular design enables several units to be coupled together to form a compartment batten.

A colour frame, safety glass and 1,5m mains cable is also included for each unit.

Diffusore asimmetrico da 1000W che consente l'illuminazione omogenea di fondali e parti di scena anche da angolazioni oblique. E' dotato di serie di doppio microinterruttore e sportello anteriore basculante e consente il montaggio in modulo lineare o quadro di più unità. Fornito di serie di telaio portagelatina, vetro di protezione e 1,5m cavo di alimentazione.

ACCESSORIES

- 20100112 colour frame, black
- 20100112B colour frame, white
- 20100112C colour frame, silver
- 20100212 safety guard, black
- 20100492 4-leaf barndoor, black
- 20100492B 4-leaf barndoor, white
- 20100492C 4-leaf barndoor, silver
- 20100512 2-leaf barndoor, black
- 20100512B 2-leaf barndoor, white
- 20100512C 2-leaf barndoor, silver
- 20100612 3-leaf barndoor, black
- 20100612B 3-leaf barndoor, white
- 20100612C 3-leaf barndoor, silver
- 20101912 kit for square mounting
- 20102612 kit for linear mounting 2/3 Innos
- 20102614 kit for linear mounting 4 Innos
- 20100900 hook clamp
- 20101300 safety bond

PHOTOMETRIC DATA P2/7

HORIZONTAL	m Ø	4,8	7,2	9,5	11,9	14,3	16,7	19,1	21,5	23,8
	lux	4.688	2.083	1.172	750	521	383	293	231	188
	m	2	3	4	5	6	7	8	9	10
VERTICAL	m Ø	5,7	8,6	11,4	14,3	17,1	20,0	22,9	25,7	28,6
	lux	4.950	2.200	1.238	792	550	404	309	244	198
	m	2	3	4	5	6	7	8	9	10

INNO S 1000



10806060 black
 10806061 white
 10806062 silver



COMPATIBLE LAMPS

P2/10	R7s	625W	230V/240V	3200K	150hrs
P2/7	R7s	1000W	230V/240V	3200K	200hrs
P2/12	R7s	1250W	230V/240V	3200K	200hrs

LDR recommends Philips lamps

Available to special order with extended front chassis for longer gel life.

Su richiesta disponibile anche con telaio anteriore esteso per gelatine dai colori saturi.

Also for larger venues, this 1000W symmetric floodlight produces a wide, even wash of light for general lighting purposes.

Each unit is complete with a safety glass and a double microswitch interlock for safe lamp replacement. The modular design enables several units to be coupled together to form a compartment batten.

A colour frame, safety glass and 1,5m mains cable is included as a standard.

Diffusore simmetrico da 1000W adatto all'impiego su grandi aree per l'illuminazione generale d'ambiente. E' dotato di serie di doppio microinterruttore e sportello anteriore basculante, e consente il montaggio in modulo lineare o quadro di più unità. Fornito di serie di telaio portagelatina, vetro di protezione e 1,5m cavo di alimentazione.

PRODUCT SPECS

reflector
aluminium, symmetrical

microswitch
double-pole

colour frame
290x270mm

throw
2-10m

weight
5,3kg

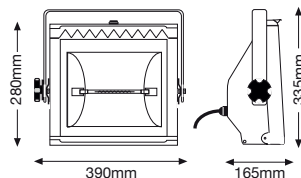

ACCESSORIES

20100112	colour frame, black
20100112B	colour frame, white
20100112C	colour frame, silver
20100212	safety guard, black
20100492	4-leaf barndoor, black
20100492B	4-leaf barndoor, white
20100492C	4-leaf barndoor, silver
20100512	2-leaf barndoor, black
20100512B	2-leaf barndoor, white
20100512C	2-leaf barndoor, silver
20100612	3-leaf barndoor, black
20100612B	3-leaf barndoor, white
20100612C	3-leaf barndoor, silver
20101912	kit for square mounting
20102612	kit for linear mounting 2/3 Innos
20102614	kit for linear mounting 4 Innos
20100900	hook clamp
20101300	safety bond

PHOTOMETRIC DATA P2/7

HORIZONTAL	m Ø	4,0	6,0	8,0	10,0	12,0	14,0	16,0	18,0	20,0
	lux	4.875	2.167	1.219	750	542	398	305	241	195
m	2	3	4	5	6	7	8	9	10	
VERTICAL	m Ø	4,4	6,5	8,7	10,9	13,1	15,3	17,5	19,6	21,8
	lux	5.125	2.278	1.281	820	569	418	320	253	205
m	2	3	4	5	6	7	8	9	10	



Strong aluminium housing for PAR64 lamps fitted with rear lamp rotator. Standard delivery includes a colour frame and a wiring kit.

Robusto alloggiamento in alluminio per lampade PAR64, dotato di dispositivo di rotazione lampada incorporato. La dotazione standard comprende telaio porta-gelatina e kit di cablaggio.

COMPATIBLE LAMPS

CP60/vnsp	GX 16D	1000W	230V/240V	3200K	300hrs
CP61/nsp	GX 16D	1000W	230V/240V	3200K	300hrs
CP62/mfl	GX 16D	1000W	230V/240V	3200K	300hrs

LDR recommends Philips lamps

PRODUCT SPECS

colour frame
255x255mm

throw
2-15m

weight
1,8kg

ACCESSORIES

20100118	colour frame, black
20100318	4-leaf barndoor
20100900	hook clamp
20101300	safety bond
20106019	colour scroller Xpress 19

PHOTOMETRIC DATA CP60

m Ø	3,9	4,7	5,5	6,3	7,1	7,9	8,7	9,5	10,2
lux	8.960	6.222	4.571	3.500	2.765	2.240	1.851	1.556	1.325
m	5	6	7	8	9	10	11	12	13



LEDS



01203020 3200K warm white

01203120 5600K cool white



ACCESSORIES

- 20100106 colour frame, black
- 20100706 iris diaphragm
- 20100806 gobo holder, A/B size
- 20100900 hook clamp
- 20101300 safety bond
- 20106019 colour scroller Xpress 19

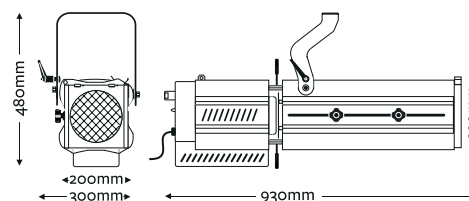

A high efficiency, powerful 200W led module featuring a PWM dimming power source harnessed in the high specification optics of LDR profile spotlights.

With a CRI rated >90, its excellent optical performance at any angle and beam shaping and an outstanding light output, the new Alba range is the professionals choice for all those applications where heat is an issue, power supply is limited and running costs need to be significantly reduced.

Alba riunisce l'elevatissima efficienza di un modulo LED da 200W a tecnologia dimmer PWM e l'ormai nota alta qualità ottica e meccanica dei sagomatori LDR.

Grazie ad un CRI (Colour Rendering Index) >90, l'eccelsa precisione di proiezione a qualsiasi angolo e sagomatura del fascio e l'incredibilmente omogenea resa ottica, la nuova gamma dei sagomatori Alba è la scelta ideale dei professionisti per tutte quelle installazioni dove la riduzione del calore, un limitato consumo di energia elettrica e la necessità di riduzione dei costi di gestione siano obiettivi prioritari.

PRODUCT SPECS

optical system
double condenser+zoom

LED array
200W, white, replaceable

rated LED life
50.000 hrs at 25°C

beam colour temperature
3200k and 5600k

CRI - colour rendering Index
>90

dimmer module
PWM (Pulse Width Modulation)

supply volts
100/260VAC single phase

colour frame
185x185mm

throw
2-15m

beam angle
8°-22°

weight
16,3 kg

PHOTOMETRIC DATA

3200K

NARROW	m Ø	1,0	1,1	1,3	1,4	1,5	1,7	1,8	2,0	2,1
	lux	2.904	2.223	1.757	1.423	1.176	988	842	726	632
	m	7	8	9	10	11	12	13	14	15
WIDE	m Ø	0,8	1,2	1,6	1,9	2,3	2,7	3,1	3,5	3,9
	lux	16.325	7.256	4.081	2.612	1.814	1.333	1.020	806	653
	m	2	3	4	5	6	7	8	9	10

PHOTOMETRIC DATA

5600K

NARROW	m Ø	1,0	1,1	1,3	1,4	1,5	1,7	1,8	2,0	2,1
	lux	3.141	2.405	1.900	1.539	1.272	1.069	911	785	684
	m	7	8	9	10	11	12	13	14	15
WIDE	m Ø	0,8	1,2	1,6	1,9	2,3	2,7	3,1	3,5	3,9
	lux	16.075	7.144	4.019	2.572	1.786	1.312	1.005	794	643
	m	2	3	4	5	6	7	8	9	10

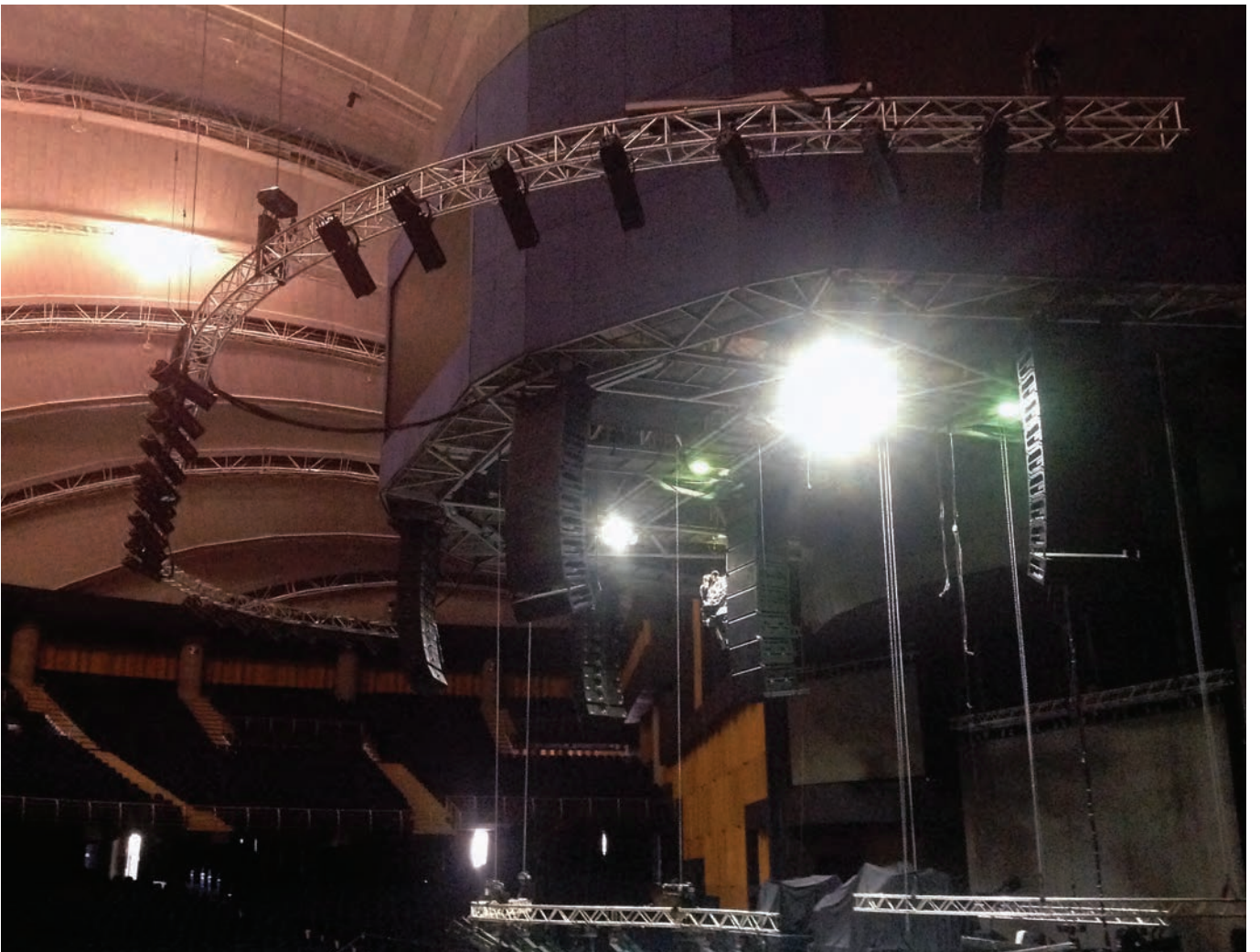

01203030 3200K warm white

01203130 5600K cool white



ACCESSORIES

- 20100106 colour frame, black
- 20100706 iris diaphragm
- 20100806 gobo holder, A/B size
- 20100900 hook clamp
- 20101300 safety bond
- 20106019 colour scroller Xpress 19

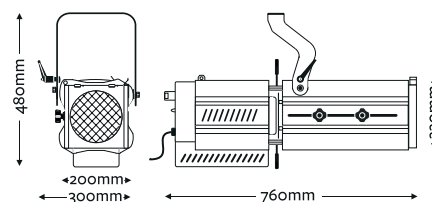

A high efficiency, powerful 200W led module featuring a PWM dimming power source harnessed in the high specification optics of LDR profile spotlights.

With a CRI rated >90, its excellent optical performance at any angle and beam shaping and an outstanding light output, the new Alba range is the professionals choice for all those applications where heat is an issue, power supply is limited and running costs need to be significantly reduced.

Alba riunisce l'elevatissima efficienza di un modulo LED da 200W a tecnologia dimmer PWM e l'ormai nota alta qualità ottica e meccanica dei sagomatori LDR.

Grazie ad un CRI (Colour Rendering Index) >90, l'eccelsa precisione di proiezione a qualsiasi angolo e sagomatura del fascio e l'incredibilmente omogenea resa ottica, la nuova gamma dei sagomatori Alba è la scelta ideale dei professionisti per tutte quelle installazioni dove la riduzione del calore, un limitato consumo di energia elettrica e la necessità di riduzione dei costi di gestione siano obiettivi prioritari.

PRODUCT SPECS

optical system
double condenser+zoom

LED array
200W, white, replaceable

rated LED life
50.000 hrs at 25°C

beam colour temperature
3200k and 5600k

CRI - colour rendering Index
>90

dimmer module
PWM (Pulse Width Modulation)

supply volts
100/260VAC single phase

colour frame
185x185mm

throw
2-15m

beam angle
18°-36°

weight
16,1 kg

PHOTOMETRIC DATA

3200K

NARROW	m Ø	1,6	1,9	2,2	2,5	2,9	3,2	3,5	3,8	4,1
	lux	4.740	3.292	2.418	1.852	1.463	1.185	979	823	701
WIDE	m	5	6	7	8	9	10	11	12	13
	m Ø	1,3	1,9	2,6	3,2	3,9	4,5			
WIDE	lux	6.689	2.973	1.672	1.070	743	546			
	m	2	3	4	5	6	7			

PHOTOMETRIC DATA

5600K

NARROW	m Ø	2,2	2,5	2,9	3,2	3,5	3,8	4,1	4,4	4,8
	lux	3.057	2.341	1.849	1.498	1.238	1.040	886	764	666
WIDE	m	7	8	9	10	11	12	13	14	15
	m Ø	1,3	1,9	2,6	3,2	3,9	4,5	5,2	5,8	6,5
WIDE	lux	9.855	4.380	2.464	1.577	1.095	804	616	487	394
	m	2	3	4	5	6	7	8	9	10

ALBA 30/55



01203040 3200K warm white

01203140 5600K cool white



ACCESSORIES

- 20100106 colour frame, black
- 20100706 iris diaphragm
- 20100806 gobo holder, A/B size
- 20100900 hook clamp
- 20101300 safety bond
- 20106019 colour scroller Xpress 19

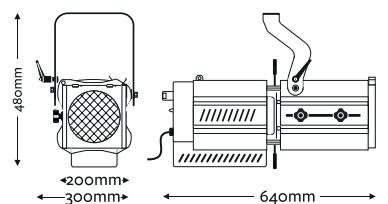

A high efficiency, powerful 200W led module featuring a PWM dimming power source harnessed in the high specification optics of LDR profile spotlights.

With a CRI rated >90, its excellent optical performance at any angle and beam shaping and an outstanding light output, the new Alba range is the professionals choice for all those applications where heat is an issue, power supply is limited and running costs need to be significantly reduced.

Alba riunisce l'elevatissima efficienza di un modulo LED da 200W a tecnologia dimmer PWM e l'ormai nota alta qualità ottica e meccanica dei sagomatori LDR.

Grazie ad un CRI (Colour Rendering Index) >90, l'eccelsa precisione di proiezione a qualsiasi angolo e sagomatura del fascio e l'incredibilmente omogenea resa ottica, la nuova gamma dei sagomatori Alba è la scelta ideale dei professionisti per tutte quelle installazioni dove la riduzione del calore, un limitato consumo di energia elettrica e la necessità di riduzione dei costi di gestione siano obiettivi prioritari.

PRODUCT SPECS

optical system
double condenser+zoom

LED array
200W, white, replaceable

rated LED life
50.000 hrs at 25°C

beam colour temperature
3200k and 5600k

CRI - colour rendering Index
>90

dimmer module
PWM (Pulse Width Modulation)

supply volts
100/260VAC single phase

colour frame
185x185mm

throw
2-10m

beam angle
30°-55°

weight
15,9 kg

PHOTOMETRIC DATA

3200K

NARROW	m Ø	1,1	1,6	2,1	2,7	3,2	3,8	4,3
	lux	8.400	3.733	2.100	1.344	933	686	525
WIDE	m	2	3	4	5	6	7	8
	m Ø	2,1	3,1	4,2	5,2	6,2		
WIDE	lux	4.025	1.789	1.006	644	447		
	m	2	3	4	5	6		

PHOTOMETRIC DATA

5600K

NARROW	m Ø	1,1	1,6	2,1	2,7	3,2	3,8	4,3	4,8	5,4
	lux	13.525	6.011	3.381	2.164	1.503	1.104	845	668	541
WIDE	m	2	3	4	5	6	7	8	9	10
	m Ø	2,1	3,1	4,2	5,2	6,2	7,3			
WIDE	lux	6.525	2.900	1.631	1.044	725	533			
	m	2	3	4	5	6	7			



ASTRO 200W



01207070 3200K warm white
K01207070 3200K warm white, kit

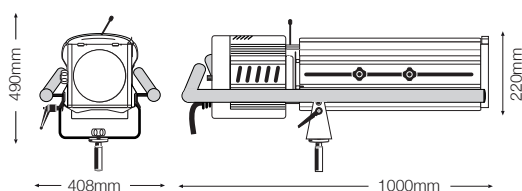

A high efficiency, powerful 200W led module featuring a PWM dimming power source harnessed in the high specification optics of LDR followspots.

Dimming is fast and accurate with a resolution of up to 512 steps controlled from a single channel through DMX/RDM signal or from a control knob positioned on the rear panel of the unit.

Standard delivery includes a 1,5m Powercon mains cable, a metal colour frame, iris and 29mm spigot for tripod.

Astro è la sintesi tra l'elevatissima efficienza di un modulo LED da 200W a tecnologia dimmer PWM e l'ormai nota altissima qualità ottica e meccanica dei seguipersona LDR.

Consente un controllo ed un dimeraggio luce particolarmente accurato con una risoluzione di fino a 512 passi tramite un solo canale DMX/RDM o, manualmente, attraverso un volantino di controllo posizionato sul pannello posteriore del seguipersona.

Viene fornito di serie completo di telaio porta gelatina, diaframma, perno per stativo e cavo di alimentazione con Powercon.

SPECIALS

ASTRO 200W KIT includes/comprende

followspot	seguipersona
colour changer, on	cambia colori, montato
black tripod	stativo nero
flight case	flight case

ACCESSORIES

20100106	colour frame, black
20100707	iris diaphragm
20100807	gobo holder, A/B size
20105106	5-col. colour changer
20102200	29mm dia. spigot
20102401	black followspot tripod
20102402	chrome followspot tripod
20107180	flight case braking wheels, colour changer on
20109106	colour frame + front runners for kit

PRODUCT SPECS

optical system

double condenser+zoom

LED array

200W, white, replaceable

rated LED life

50.000 hrs at 25°C

beam colour temperature

3200K

CRI - colour rendering Index

>90

dimmer module

PWM (Pulse Width Modulation)

supply volts

100/260VAC single phase

colour frame

185x185mm

throw

2-20m

beam angle

8°-22°

weight

19,5 kg - 62,7 kg kit

PHOTOMETRIC DATA

3200K

	m Ø	1,0	1,1	1,3	1,4	1,5	1,7	1,8	2,0	2,1
NARROW	lux	3.214	2.461	1.944	1.575	1.302	1.094	932	804	700
	m	7	8	9	10	11	12	13	14	15
WIDE	m Ø	0,8	1,2	1,6	1,9	2,3	2,7	3,1	3,5	3,9
	lux	29.800	13.244	7.450	4.768	3.311	2.433	1.863	1.472	1.192
	m	2	3	4	5	6	7	8	9	10

ASTRO 200 C



01207080 5600K warm white
K01207080 5600K warm white, kit

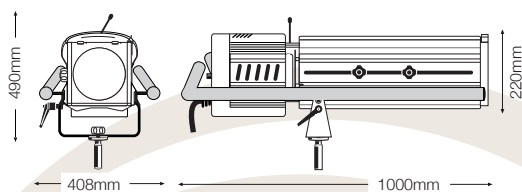

SPECIALS

ASTRO 200C KIT includes/comprende

followspot	seguipersona
colour changer, on	cambia colori, montato
black tripod	stativo nero
flight case	flight case

ACCESSORIES

20100106	colour frame, black
20100707	iris diaphragm
20100807	gobo holder, A/B size
20105106	5-col. colour changer
20102200	29mm dia. spigot
20102401	black followspot tripod
20102402	chrome followspot tripod
20107180	flight case braking wheels, colour changer on
20109106	colour frame + front runners for kit

PRODUCT SPECS

optical system
double condenser+zoom

LED array
200W, white, replaceable

rated LED life
50.000 hrs at 25°C

beam colour temperature
5600k

CRI - colour rendering Index
>90

dimmer module
PWM (Pulse Width Modulation)

supply volts
100/260VAC single phase

colour frame
185x185mm

throw
2-20m

beam angle
8°-22°

weight
19,5 kg - 62,7 kg kit

A high efficiency, powerful 200W led module featuring a PWM dimming power source harnessed in the high specification optics of LDR followspots.

Dimming is fast and accurate with a resolution of up to 512 steps controlled from a single channel through DMX/RDM signal or from a control knob positioned on the rear panel of the unit.

Standard delivery includes a 1,5m Powercon mains cable, a metal colour frame, iris and Ø29mm spigot for tripod.

Astro è la sintesi tra l'elevatissima efficienza di un modulo LED da 200W a tecnologia dimmer PWM e l'ormai nota altissima qualità ottica e meccanica dei seguipersona LDR.

Consente un controllo ed un dimeraggio luce particolarmente accurato con una risoluzione di fino a 512 passi tramite un solo canale DMX/RDM o, manualmente, attraverso un volantino di controllo posizionato sul pannello posteriore del seguipersona.

Viene fornito di serie completo di telaio porta gelatina, diaframma, perno per stativo e cavo di alimentazione con Powercon.

PHOTOMETRIC DATA

5600K

NARROW	m Ø	1,0	1,1	1,3	1,4	1,5	1,7	1,8	2,0	2,1
	lux	3.959	3.031	2.395	1.940	1.603	1.347	1.148	990	862
WIDE	m	7	8	9	10	11	12	13	14	15
	lux	38.250	17.000	9.563	6.120	4.250	3.122	2.391	1.889	1.530
	m	2	3	4	5	6	7	8	9	10



ARCHITECTURAL



RIMA A 70

10076050 black
10076051 white
10076052 silver

RIMA A 150

10156050 black
10156051 white
10156052 silver

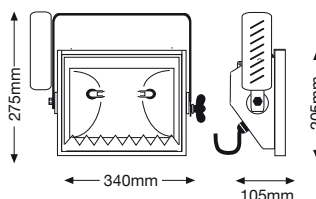

COMPATIBLE LAMPS

CDM TD/830	RX7s	70W	3000K	15000 hrs
CDM TD/942	RX7s	70W	4200K	15000 hrs
CDM TD/830	RX7s	150W	3000K	15000 hrs
CDM TD/942	RX7s	150W	4200K	15000 hrs

LDR recommends Philips lamps

PRODUCT SPECS

reflector
aluminium, asymmetrical

microswitch
no

colour frame
244x195mm

ballast
built-in-electronic

throw
2-5m (70W) / 2-10m (150W)

voltage
220V / 240V

weight
3,8kg

Stylish and high specification 70W and 150W asymmetrical discharge floodlight ideal for usage in architectural, display and retail areas. The unit is equipped with an electronic ballast unit and is supplied complete with safety glass, colour frame and 1,5m mains cable.

Diffusore asimmetrico per lampade a scarica CDM-TD da 70W o 150W, ideale per utilizzo in ambientazioni di tipo architeturale, quali, ad esempio, vetrine, show-room o stand fieristici. Dotato di ballast elettronico, viene fornito completo di vetro termico, telaio portagelatina ed 1,5m cavo di alimentazione.

RIMA A 70 PHOTOMETRIC DATA CDM-TD 70

HORIZONTAL	m Ø	3,1	4,7	6,2	7,8	9,4	11	12,5	14
	lux	780	347	195	125	87	64	49	39
VERTICAL	m	2	3	4	5	6	7	8	9
	m Ø	1,9	2,8	3,7	4,7	5,6	6,5	7,5	8,4
VERTICAL	lux	1.050	467	263	168	117	86	66	52
	m	2	3	4	5	6	7	8	9

RIMA A 150 PHOTOMETRIC DATA CDM-TD 150

HORIZONTAL	m Ø	3,1	4,7	6,2	7,8	9,4	11	12,5	14
	lux	1.300	578	325	208	144	106	81	64
VERTICAL	m	2	3	4	5	6	7	8	9
	m Ø	1,9	2,8	3,7	4,7	5,6	6,5	7,5	8,4
VERTICAL	lux	1.749	777	437	280	194	143	109	86
	m	2	3	4	5	6	7	8	9

ACCESSORIES

- 20100120 colour frame, black
- 20100120B colour frame, white
- 20100120C colour frame, silver
- 20100220 safety guard, black
- 20100420 4-leaf barndoor, black
- 20100420B 4-leaf barndoor, white
- 20100420C 4-leaf barndoor, silver
- 20100420D 4-leaf barndoor, white/black
- 20100420E 4-leaf barndoor, silver/black
- 20101420 safety glass
- 20100900 hook clamp
- 20101300 safety bond

RIMA S 70

10076060 black
10076061 white
10076062 silver

RIMA S 150

10156060 black
10156061 white
10156062 silver



COMPATIBLE LAMPS

CDM TD/830	RX7s	70W	3000K	15000 hrs
CDM TD/942	RX7s	70W	4200K	15000 hrs
CDM TD/830	RX7s	150W	3000K	15000 hrs
CDM TD/942	RX7s	150W	4200K	15000 hrs

LDR recommends Philips lamps

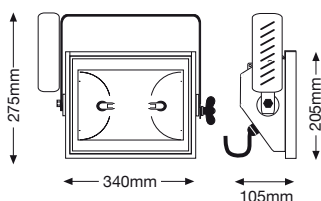

Stylish and high specification 70W and 150W symmetrical discharge floodlight ideal for usage in architectural, display and retail areas. The unit is equipped with an electronic ballast unit and is supplied complete with safety glass, colour frame and 1,5m mains cable.

Diffusore simmetrico per lampade a scarica CDM-TD da 70 e 150W, ideale per utilizzo in ambientazioni di tipo architettrale, quali, ad esempio, vetrine, show-room o stand fieristici. Dotato di ballast elettronico, viene fornito completo di vetro termico, telaio portagelatina ed 1,5m cavo di alimentazione.

PRODUCT SPECS

reflector
aluminium, symmetrical

microswitch
no

colour frame
244x195mm

throw
2-5m (70W) / 2-10m (150W)

voltage
220V / 240V

weight
3,8kg

RIMA S 70 PHOTOMETRIC DATA CDM-TD 70

HORIZONTAL	m Ø	3,2	4,9	6,5	8,1	9,7	11,3	13	14,6
	lux	450	200	113	72	50	37	29	23
m	2	3	4	5	6	7	8	9	
VERTICAL	m Ø	1,9	2,8	3,7	4,7	5,6	6,5	7,5	8,4
	lux	660	294	165	106	74	54	42	33
m	2	3	4	5	6	7	8	9	

RIMA S 150 PHOTOMETRIC DATA CDM-TD 150

HORIZONTAL	m Ø	3,2	4,9	6,5	8,1	9,7	11,3	13	14,6
	lux	760	338	190	122	84	62	48	38
m	2	3	4	5	6	7	8	9	
VERTICAL	m Ø	1,9	2,8	3,7	4,7	5,6	6,5	7,5	8,4
	lux	1.100	489	275	176	122	90	69	54
m	2	3	4	5	6	7	8	9	

ACCESSORIES

20100121	colour frame, black
20100121B	colour frame, white
20100121C	colour frame, silver
20100220	safety guard, black
20100420	4-leaf barndoor, black
20100420B	4-leaf barndoor, white
20100420C	4-leaf barndoor, silver
20100420D	4-leaf barndoor, white/black
20100420E	4-leaf barndoor, silver/black
20101420	safety glass
20100900	hook clamp
20101300	safety bond



SOFFIO F 70



- 10071080 black
- 10071081 white
- 10071082 silver



Stylish and high specification Fresnel luminaire for 70W CDM-T discharge lamps. Equipped with a built-in ballast, it produces a bright, soft-edged beam, which makes it ideal in architectural applications.

Available to special order in any colour from the RAL range, Soffio F70 is supplied with colour frame and 1,5m mains cable.

Illuminatore Fresnel per lampade a scarica CDM-T da 70W, Soffio F70 si distingue per la gradevole linea e le ridotte dimensioni d'ingombro, nonostante il ballast incorporato. Produce un fascio di luce omogeneo e diffuso che lo rende ideale per l'utilizzo in ambiti architeturali. Viene fornito di serie completo di telaio porta-gelatina e 1,5m cavo di alimentazione ed è disponibile su richiesta in qualsiasi colore della gamma RAL.

COMPATIBLE LAMPS

CDM -T/830 G12 70W 3000K 12000 hrs

CDM -T/942 G12 70W 4200K 12000 hrs

LDR recommends Philips lamps

PHOTOMETRIC DATA CDM-TD 70/942

	SPOT						
m Ø	0,2	0,4	0,5	0,6	0,7	0,9	
lux	7.500	3.333	1.875	1.200	833	612	
m	2	3	4	5	6	7	
	FLOOD						
m Ø	2	3,1	4,1	5,1	6,1	7,1	
lux	1.250	556	313	200	139	102	
m	2	3	4	5	6	7	

ACCESSORIES

- 20100102 colour frame, black
- 20100102B colour frame, white
- 20100102C colour frame, silver
- 20100302 4-leaf barndoor, black
- 20100302B 4-leaf barndoor, white
- 20100302C 4-leaf barndoor, silver
- 20100302D 4-leaf barndoor, white/black
- 20100302E 4-leaf barndoor, silver/black
- 20100900 hook clamp
- 20101300 safety bond

PRODUCT SPECS

lens type
120mm dia. Fresnel

reflector
55mm dia.glass

microswitch
no

ballast
built-in- PFC

colour frame
125X125mm

throw
2-10m

beam angle
7°-63°

voltage
230V

weight
5,5kg

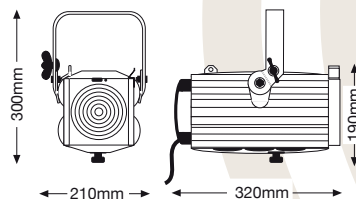

SOFFIO 10/28 70W



10073020 black

10073021 white

10073022 silver

COMPATIBLE LAMPS

CDM -T/830 G12 70W 3000K 12000 hrs

CDM -T/942 G12 70W 4200K 12000 hrs

LDR recommends Philips lamps



PRODUCT SPECS

optical system
double condenser+zoom

reflector
55mm dia.glass

microswitch
no

ballast
built-in- PFC

colour frame
125x125mm

throw
2-10m

beam angle
10°-28°

voltage
230V

weight
8,5kg

ACCESSORIES

20100102	colour frame, black
20100102B	colour frame, white
20100102C	colour frame, silver
20100701	iris diaphragm
20100812	gobo holder, M/D size
20100900	hook clamp
20101300	safety bond

Ideal for display highlighting, this 10°-28° profile spotlight uses a compact 70W discharge lamp combined with a double-condenser optical system. The cool beam design enables a wide range of metal, dichroic or acetate gobos and slides to be used to project images in architectural applications.

Available to special order in any colour from the RAL range, Soffio 10/28 is supplied with a built-in ballast, colour frame, 4 shutter blades and 1,5m mains cable.

Sagomatore a scarica da 70W con ottica a zoom 10°-28°, ideale per l'illuminazione di dettaglio o la proiezione di immagini da gobo in metallo o materiale plastico in ambiti architeturali. Disponibile su richiesta in qualsiasi colore della gamma RAL, viene fornito di serie con ballast incorporato, portagelatina, 4 ghigliottine sagomatrici ed 1,5m cavo di alimentazione.

gobo wizard®

Freeware for the creation of customized gobos on acetate film.
(see pag.86)

Freeware per la creazione di gobo personalizzati su base in acetato.
(v. pag.86)

PHOTOMETRIC DATA CDM-T 70/942

	m Ø	0,3	0,5	0,7	0,9	1,0	1,2
NARROW	lux	5.880	2.613	1.470	941	653	480
	m	2	3	4	5	6	7
WIDE	m Ø	1,0	1,5	2,0	2,5	3,0	3,5
	lux	1.500	667	375	240	167	122
	m	2	3	4	5	6	7

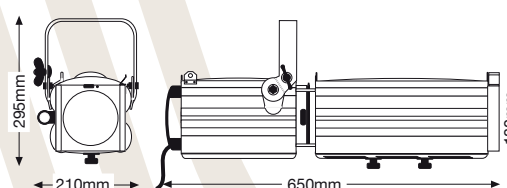

SOFFIO 20/40 70W



- 10073030 black
- 10073031 white
- 10073032 silver



COMPATIBLE LAMPS

CDM -T/830	G12	70W	3000K	12000 hrs
CDM -T/942	G12	70W	4200K	12000 hrs

LDR recommends Philips lamps

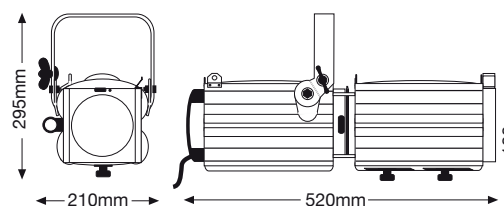

Ideal for closer-range highlighting, this 20°-40° profile spotlight produces a crisp flat beam particularly suited for projecting patterns or advertising logos in architectural and display applications. Available to special order in any colour from the RAL range, Soffio 20/40 is supplied with a built-in ballast, colour frame, 4 shutter blades and 1.5m mains cable.

Sagomatore a scarica da 70W con ottica a zoom 20°-40°, ideale per l'illuminazione di dettaglio o la proiezione di immagini da gobo in metallo o materiale plastico in ambiti architeturali. Disponibile su richiesta in qualsiasi colore della gamma RAL, viene fornito di serie con ballast incorporato, portagelatina, 4 ghigliottine sagomatrici ed 1.5m cavo di alimentazione.

gobo wizard®

Freeware for the creation of customized gobos on acetate film.
(see pag.86)

Freeware per la creazione di gobo personalizzati su base in acetato.
(v. pag.86)

ACCESSORIES

20100102	colour frame, black
20100102B	colour frame, white
20100102C	colour frame, silver
20100701	iris diaphragm
20100812	gobo holder, M/D size
20100900	hook clamp
20101300	safety bond

PRODUCT SPECS

optical system	double condenser+zoom
reflector	55mm dia.glass
microswitch	no
ballast	built-in- PFC
colour frame	125x125mm
throw	2-10m
beam angle	20°-40°
voltage	230V
weight	8,0kg

PHOTOMETRIC DATA CDM-T 70/942

NARROW	m Ø	1,5	2,2	2,9	3,6	4,4	5,1	
	lux	1.060	471	265	170	118	87	
		m	2	3	4	5	6	7
WIDE	m Ø	0,7	1,1	1,4	1,8	2,1	2,5	
	lux	2.750	1.222	688	440	306	224	
		m	2	3	4	5	6	7



SOFFIO F 150

LDR
lucidella ribalta

10151080 black

10151081 white

10151082 silver



COMPATIBLE LAMPS

CDM -T/830	G12	150W	3000K	9000 hrs
CDM -T/942	G12	150W	4200K	9000 hrs
CDM -T SA/942	G12	150W	4200K	6000 hrs

LDR recommends Philips lamps

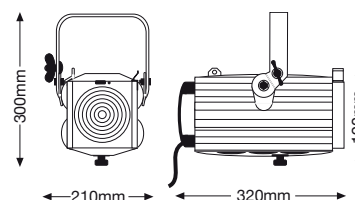

Ideal for display lighting and theatrical-style illumination of architectural spaces, the Soffio Fresnel produces a bright soft-edged beam, variable from 7° to 63°, shaped using an optional 4- leaf barndoor accessory.

Available to special order in any colour from the RAL range, Soffio f150 is supplied with a built-in ballast, colour frame and 1,5m mains cable.

Piccolo illuminatore fresnel per lampade a scarica CDM-T 150W, ideale per l'illuminazione di negozi, centri commerciali, gallerie d'arte o musei, e per tutti quegli impieghi dove si richiedano potenza illuminometrica, assenza di calore e ridottissima manutenzione.

A richiesta è disponibile in qualsiasi colore della gamma RAL. Fornito di serie completo di ballast incorporato, telaio portagelatina e 1,5m cavo di alimentazione.

ACCESSORIES

20100102	colour frame, black
20100102B	colour frame, white
20100102C	colour frame, silver
20100302	4-leaf barndoor, black
20100302B	4-leaf barndoor, white
20100302C	4-leaf barndoor, silver
20100302D	4-leaf barndoor, white/black
20100302E	4-leaf barndoor, silver/black
20100900	hook clamp
20101300	safety bond

PRODUCT SPECS

lens type
120mm dia. Fresnel

reflector
55mm dia.glass

microswitch
no

ballast
built-in- PFC

colour frame
125X125mm

throw
2-15m

beam angle
7°-63°

voltage
230V

weight
6,0kg

PHOTOMETRIC DATA CDM-T 150/942

SPOT	m Ø	0,2	0,4	0,5	0,6	0,7	0,9	1	1,1	1,2
	lux	13.360	5.938	3.340	2.138	1.484	1.091	835	660	534
	m	2	3	4	5	6	7	8	9	10
FLOOD	m Ø	2	3,1	4,1	5,1	6,1	7,1	8,2	9,2	10,2
	lux	1.800	800	450	288	200	147	113	89	72
	m	2	3	4	5	6	7	8	9	10

SOFFIO 10/28 150W



10153020 black

10153021 white

10153022 silver



COMPATIBLE LAMPS

CDM -T/830 G12 150W 3000K 9000 hrs

CDM -T/942 G12 150W 4200K 9000 hrs

CDM -T SA/942 G12 150W 4200K 6000 hrs

LDR recommends Philips lamps

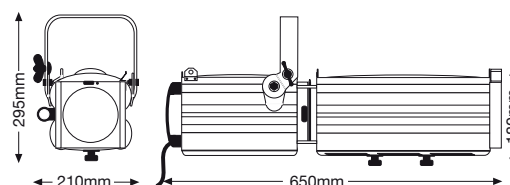

Stylish, narrow-angle double condenser profile spotlight for 150W CDM-T discharge lamps, ideal for architectural and display applications. The cool and crisp beam enables a wide range of metal or acetate gobos or slides to be projected.

Available to special order in any colour from the RAL range, Soffio 10/28 is supplied with a built-in PFC ballast, colour frame, 4 shutter blades and 1,5m mains cable.

Sagomatore a scarica da 150W con ottica a zoom 10°-28°, ideale per illuminazione di dettaglio o la proiezione di immagini da gobo in metallo o materiale plastico in ambiti architeturali. Elegante nella linea e preciso nell'ottica, è disponibile su richiesta in qualsiasi colore della gamma RAL.

Viene fornito di serie con ballast incorporato, porta-gelatina, 4 ghigliottine sagomatrici ed 1,5m cavo di alimentazione.

PRODUCT SPECS

optical system
double condenser+zoom

reflector
55mm dia.glass

microswitch
no

ballast
built-in- PFC

colour frame
125x125mm

throw
2-15m

beam angle
10°-28°

voltage
230V

weight
9kg

ACCESSORIES

20100102 colour frame, black

20100102B colour frame, white

20100102C colour frame, silver

20100701 iris diaphragm

20100812 gobo holder, M/D size

20100900 hook clamp

20101300 safety bond

gobo wizard®

Freeware for the creation of customized gobos on acetate film.
(see pag.86)

Freeware per la creazione di gobo personalizzati su base in acetato.
(v. pag.86)

PHOTOMETRIC DATA CDM-T 150/942

NARROW	m Ø	1,2	1,4	1,6	1,7	1,9	2,1	2,3	2,4	2,6
	lux	800	613	484	392	324	272	232	200	174
	m	7	8	9	10	11	12	13	14	15
WIDE	m Ø	1,0	1,5	2,0	2,5	3,0	3,5	4,0	4,5	5,0
	lux	2.560	1.138	640	410	284	209	160	126	102
	m	2	3	4	5	6	7	8	9	10

SOFFIO 20/40 150W



- 10153030 black
- 10153031 white
- 10153032 silver



COMPATIBLE LAMPS

CDM -T/830	G12	150W	3000K	9000 hrs
CDM -T/942	G12	150W	4200K	9000 hrs
CDM -T SA/942	G12	150W	4200K	6000 hrs

LDR recommends Philips lamps

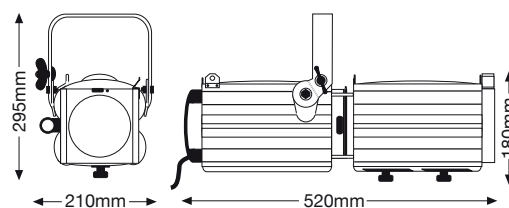

Stylish, wide-angle double condenser profile spotlight for 150W CDM-T discharge lamps, ideal for closer-range highlighting in architectural applications.

The cool and crisp beam enables a wide range of metal or acetate gobos or slides to be projected. Available to special order in any colour from the RAL range, Soffio 20/40 is supplied with a built-in PFC ballast, colour frame, 4 shutter blades and 1,5m mains cable.

Sagomatore a scarica da 150W con ottica a zoom 20°-40°, ideale per l'illuminazione di dettaglio o la proiezione di immagini da gobo in metallo o materiale plastico in ambiti architeturali. Elegante nella linea e preciso nell'ottica, è disponibile su richiesta in qualsiasi colore della gamma RAL.

Viene fornito di serie con ballast incorporato, porta-gelatina, 4 ghigliottine sagomatrici ed 1,5m cavo di alimentazione.

PRODUCT SPECS

optical system
double condenser+zoom

reflector
55mm dia.glass

microswitch
no

ballast
built-in- PFC

colour frame
125x125mm

throw
2-15m

beam angle
20°-40°

voltage
230V

weight
8,5kg

ACCESSORIES

20100102	colour frame, black
20100102B	colour frame, white
20100102C	colour frame, silver
20100701	iris diaphragm
20100812	gobo holder, M/D size
20100900	hook clamp
20101300	safety bond

gobo wizard®

Freeware for the creation of customized gobos on acetate film.
(see pag.86)

Freeware per la creazione di gobo personalizzati su base in acetato.
(v. pag.86)

PHOTOMETRIC DATA CDM-T 150/942

NARROW	m Ø	2,5	2,8	3,2	3,5	3,9	4,2	4,6	4,9	5,3
	lux	372	285	225	182	151	127	108	93	81
	m	7	8	9	10	11	12	13	14	15
WIDE	m Ø	1,5	2,2	2,9	3,6	4,4	5,1	5,8	6,6	7,3
	lux	1.560	693	390	250	173	127	98	77	62
	m	2	3	4	5	6	7	8	9	10

SUONO F 250 MSD

LDR
LUCI DELLA RIBALTA

10201080 black

10201081 white

10201082 silver



COMPATIBLE LAMPS

Philips MSD 250/2 GY9.5 8500K 3000 hrs

LDR recommends Philips lamps

PRODUCT SPECS

lens type

120mm dia. Fresnel

reflector

55mm dia. glass

microswitch

no

colour frame

150x150mm

throw

2-20 m

beam angle

7°-63°

voltage

208V / 230V / 240V

weight

8,6 kg

ACCESSORIES

20100103	colour frame, black
20100103B	colour frame, white
20100103C	colour frame, silver
20100303	4-leaf barndoor, black
20100303B	4-leaf barndoor, white
20100303C	4-leaf barndoor, silver
20100303D	4-leaf barndoor, white/black
20100303E	4-leaf barndoor, silver/black
20100900	hook clamp
20101300	safety bond

High power discharge Fresnel spotlight for display and internal architectural lighting applications. It produces a soft-edged beam with a variable beam angle ranging from 7° to 63°. A multi-frequency built-in ballast, colour frame and 1,5m mains cable are all supplied as standard. Available to special order in any colour from the RAL range.

Illuminatore fresnel per lampade a scarica 250MSD, ideale per utilizzi architeturali su aree espositive, in show room, vetrine, musei o centri commerciali.

Viene fornito di serie completo di ballast multi-frequenza incorporato, telaio porta-gelatina 150x150mm e 1,5m cavo di alimentazione.

A richiesta è disponibile in qualsiasi colore della gamma RAL.

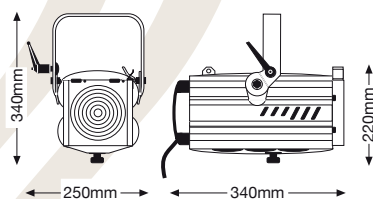

PHOTOMETRIC DATA MSD 250/2

SPOT	m Ø	0,2	0,4	0,5	0,6	0,7	0,9	1,0	1,1	1,2
	lux	23.150	10.289	5.788	3.704	2.572	1.890	1.447	1.143	926
	m	2	3	4	5	6	7	8	9	10
FLOOD	m Ø	2,5	3,7	4,9	6,1	7,4	8,6	9,7	11	12,3
	lux	3.300	1.467	825	528	367	269	206	163	132
	m	2	3	4	5	6	7	8	9	10



SUONO D 10/28 250W



- 10203020 black
- 10203021 white
- 10203022 silver



COMPATIBLE LAMPS

Philips MSD 250/2 GY9.5 8500K 3000 hrs

LDR recommends Philips lamps

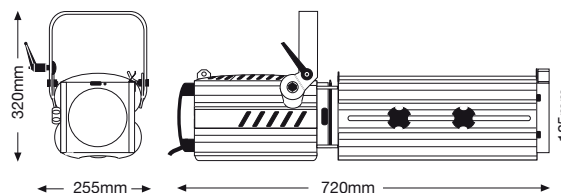

PRODUCT SPECS

optical system

double condenser+zoom

reflector

55mm dia. glass

microswitch

no

colour frame

150x150mm

throw

2-20 m

beam angle

10°-28°

voltage

208V / 230V / 240V

weight

12,4 kg

ACCESSORIES

- 20100103 colour frame, black
- 20100103B colour frame, white
- 20100103C colour frame, silver
- 20100707 iris diaphragm
- 20100801 gobo holder, M/D size
- 20100900 hook clamp
- 20101300 safety bond

Discharge profile spotlight designed for 250W MSD lamps. Ideal for longer throw applications in display, retail and architectural lighting where the versatility and precision of a theatrical luminaire combined with a high colour temperature are required. Supplied with a built-in ballast, colour frame, 4 shutter blades and 1,5m mains cable. Available to special order in any colour from the RAL range.

Sagomatore a scarica per lampade 250MSD. Ideale per l'illuminazione su distanze medio-lunghe in ambiente architeturale dove si richiedano la versatilità e precisione di un illuminatore teatrale ed al contempo una elevata temperatura di colore. Viene fornito di serie completo di ballast interno, telaio porta-gelatina, 4 ghigliottine sagomatrici e 1,5m cavo di alimentazione. A richiesta disponibile in qualsiasi colore della gamma RAL.

PHOTOMETRIC DATA MSD 250/2

NARROW	m Ø	0,3	0,5	0,7	0,9	1,0	1,4	1,7	2,1	2,4
	lux	12.650	5.622	3.163	2.024	1.406	791	506	351	258
	m	2	3	4	5	6	8	10	12	14
WIDE	m Ø	1,0	1,5	2,0	2,5	3,0	3,5	4,0	4,5	5,0
	lux	10.700	4.756	2.675	1.712	1.189	873	669	528	428
	m	2	3	4	5	6	7	8	9	10

SUONO D 20/40 250W



10203030 black

10203031 white

10203032 silver



COMPATIBLE LAMPS

Philips MSD 250/2 GY9.5 8500K 3000 hrs

LDR recommends Philips lamps

ACCESSORIES

- 20100103 colour frame, black
- 20100103B colour frame, white
- 20100103C colour frame, silver
- 20100707 iris diaphragm
- 20100801 gobo holder, M/D size
- 20100900 hook clamp
- 20101300 safety bond

The wider-angle Suono D profile spotlight has a variable zoom focus from 20° to 40°, making it suitable for short-throw applications in display, retail and architectural lighting. Suono D20/40 is supplied with a built-in ballast, colour frame, 4 shutter blades and 1,5m mains cable.

Available to special order in any colour from the RAL range.

Sagomatore ad angolo largo regolabile da 20° a 40°, ideale all'impiego in applicazioni di tipo architeturale. Dispone di ottica a doppio condensatore, alloggiamento ghigliottine girevole, ed un'ampia scelta di accessori, che lo rendono un prodotto estremamente flessibile. Fornito di serie completo di ballast interno, telaio portagelatina, 4 ghigliottine sagomatrici ed 1,5m cavo di alimentazione.

A richiesta disponibile in qualsiasi colore della gamma RAL.

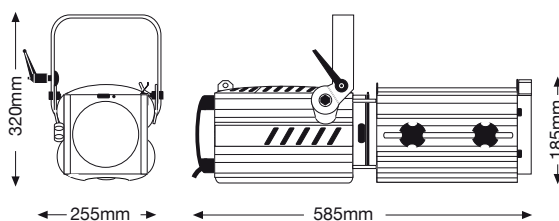

PRODUCT SPECS

optical system
double condenser+zoom

reflector
55mm dia. glass

microswitch
no

colour frame
150x150mm

throw
2-20 m

beam angle
20°-40°

voltage
208V / 230V / 240V

weight
11,8 kg

PHOTOMETRIC DATA MSD 250/2

	m Ø	0,7	1,1	1,4	1,8	2,1	2,8	3,5	4,2	4,9
NARROW	lux	11.750	5.222	2.938	1.880	1.306	734	470	326	240
	m	2	3	4	5	6	8	10	12	14
WIDE	m Ø	1,5	2,2	2,9	3,6	4,4	5,1	5,8	6,6	7,3
	lux	8.800	3.911	2.200	1.408	978	718	550	435	352
	m	2	3	4	5	6	7	8	9	10





POLE OPERATED
.....
MOVING YOKE

SOFFIO F 150 P.O.



- 12151080 black
- 12151081 white
- 12151082 silver



COMPATIBLE LAMPS

CDM -T/830	G12	150W	3000K	9000 hrs
CDM -T/942	G12	150W	4200K	9000 hrs
CDM -T SA/942	G12	150W	4200K	6000 hrs

LDR recommends Philips lamps

Stylish, high-specification Fresnel luminaire featuring a pole-operated stirrup for the control of pan and tilt. Ideal for display lighting and theatrical style illumination of architectural spaces. Available to special order in any colour from the RAL range, Soffio is supplied with built-in ballast, colour frame and 1,5m mains cable.

Piccolo illuminatore fresnel da 150W dotato di forcilla con comando a palo per il controllo della posizione orizzontale e verticale.

Ideale per l'illuminazione di negozi, centri commerciali, gallerie d'arte o musei, e per tutti quegli impieghi dove si richieda un frequente riposizionamento del fascio. A richiesta è disponibile in qualsiasi colore della gamma RAL. Fornito di serie completo di ballast incorporato, telaio portagelatina e 1,5m cavo di alimentazione.

ACCESSORIES

- 20100102 colour frame, black
- 20100102B colour frame, white
- 20100102C colour frame, silver
- 20100302 4-leaf barndoor, black
- 20100302B 4-leaf barndoor, white
- 20100302C 4-leaf barndoor, silver
- 20100302D 4-leaf barndoor, white/black
- 20100302E 4-leaf barndoor, silver/black
- 20101104 alu-grip clamp for BS spigot
- 20101300 safety bond

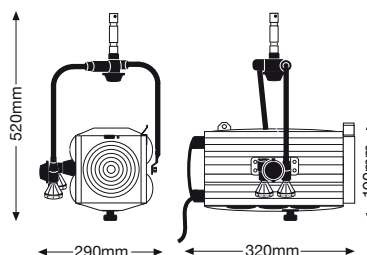

PRODUCT SPECS

lens type
120mm dia. Fresnel

reflector
55mm dia.glass

microswitch
no

colour frame
125x125mm

throw
2-15m

beam angle
7°-63°

weight
7,8kg

PHOTOMETRIC DATA CDM-T 150/942

SPOT	m Ø	0,2	0,4	0,5	0,6	0,7	0,9	1,0	1,1	1,2
	lux	13.360	5.938	3.340	2.138	1.484	1.091	835	660	534
	m	2	3	4	5	6	7	8	9	10
FLOOD	m Ø	2	3,1	4,1	5,1	6,1	7,1	8,2	9,2	10,2
	lux	1.800	800	450	288	200	147	113	89	72
	m	2	3	4	5	6	7	8	9	10

SUONO F 250 P.O.



- 12201080 black
- 12201081 white
- 12201082 silver



COMPATIBLE LAMPS

Philips MSD 250/2 GY9.5 8500K 3000 hrs

LDR recommends Philips lamps

High power discharge Fresnel spotlight for display and architectural lighting, equipped with a pole-operated stirrup for the control of pan and tilt. Available to special order in any colour from the RAL range, it is supplied with built-in ballast, colour frame and 1,5m mains cable.

Illuminatore fresnel per lampade a scarica 250 MSD ideale per utilizzi architeturali su aree espositive, in show room, vetrine, musei o centri commerciali. Dotato di forcina con comando a palo per il controllo della posizione orizzontale e verticale. Fornito di serie completo di ballast multifrequenza incorporato, telaio porta-gelatina 150x150mm e 1,5m cavo di alimentazione. A richiesta è disponibile in qualsiasi colore della gamma RAL.

ACCESSORIES

- 20100103 colour frame, black
- 20100103B colour frame, white
- 20100103C colour frame, silver
- 20100303 4-leaf barndoor, black
- 20100303B 4-leaf barndoor, white
- 20100303C 4-leaf barndoor, silver
- 20100303D 4-leaf barndoor, white/black
- 20100303E 4-leaf barndoor, silver/black
- 20101104 alu-grip clamp for BS spigot
- 20101300 safety bond

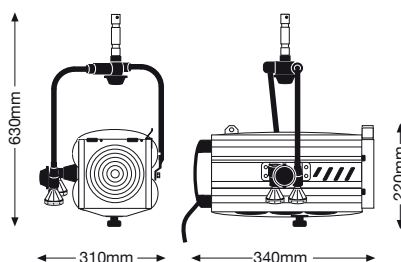

PRODUCT SPECS

lens type
120mm dia. Fresnel

reflector
55mm dia. glass

microswitch
no

colour frame
150x150mm

throw
2-20 m

beam angle
7°-63°

voltage
208V / 230V / 240V

weight
10,4 kg

PHOTOMETRIC DATA MSD 250/2

	PHOTOMETRIC DATA MSD 250/2									
SPOT	m Ø	0,2	0,4	0,5	0,6	0,7	0,9	1,0	1,1	1,2
	lux	23.150	10.289	5.788	3.704	2.572	1.890	1.447	1.143	926
	m	2	3	4	5	6	7	8	9	10
FLOOD	m Ø	2,5	3,7	4,9	6,1	7,4	8,6	9,7	11	12,3
	lux	3.300	1.467	825	528	367	269	206	163	132
	m	2	3	4	5	6	7	8	9	10

NOTA F 1200 P.O.



12851000	230V	black	13851000	120V	black
12851001	230V	white	13851001	120V	white
12851002	230V	silver	13851002	120V	silver



COMPATIBLE LAMPS

CP67	GX9.5	650W	230V/240V	3200K	120 hrs
T21	GX9.5	650W	230V/240V	3000K	900 hrs
CP70	GX9.5	1000W	230V/240V	3200K	240 hrs
T19	GX9.5	1000W	230V/240V	3050K	900 hrs
CP90	GX9.5	1200W	230V/240V	3200K	240 hrs
T29	GX9.5	1200W	230V/240V	3000K	480 hrs
EGT	G22	1000W	120V/240V	3200K	300 hrs

LDR recommends Philips lamps

Quality 1/1200W fresnel spotlight fitted with a pole-operated stirrup to control pan and tilt movement. It's ideal for all those applications where the luminaires are difficult to access and whose position needs to be changed frequently. It includes screw focus variable spread soft-edged beam, front hinging lamp tray, adjustable lampbase and double-microswitch interlock for safe lamp replacement. A colour frame, safety guard and 1,5m mains cable are included as standard.

Illuminatore Fresnel da 1/1200W di elevata qualità ottica con forcella per comando a palo del posizionamento orizzontale e verticale.

Ideale per tutte quelle installazioni con illuminatori di difficile accesso e la cui posizione debba essere modificata di frequente. Fornito di serie completo di telaio porta-gelatina, rete di protezione, forcella P.O. con spinotto BS e 1,5m cavo di alimentazione.

ACCESSORIES

20100106	colour frame, black
20100106B	colour frame, white
20100106C	colour frame, silver
20100306	4-leaf barndoor, black
20100306B	4-leaf barndoor, white
20100306C	4-leaf barndoor, silver
20100306D	4-leaf barndoor, white/black
20100306E	4-leaf barndoor, silver/black
20101104	alu-grip clamp for BS spigot
20101300	safety bond

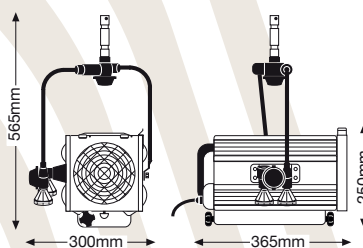

PRODUCT SPECS

lens type

150mm dia. Fresnel

reflector

100mm dia. aluminium

microswitch

double-pole

colour frame

185x185 mm

throw

2-15 m

beam angle

10°-56°

lamp base

GX9.5 (230V) - G22 (120V)

weight

7,3kg (230V) - 7,5kg (120V)

PHOTOMETRIC DATA CP90

SPOT	m Ø	1,2	1,4	1,6	1,7	1,9	2,1	2,3	2,4	2,6
	lux	2.612	2.000	1.580	1.280	1.058	889	757	653	569
	m	7	8	9	10	11	12	13	14	15
FLOOD	m Ø	2,1	3,2	4,3	5,3	6,4	7,4	8,5	9,6	10,6
	lux	3.200	1.422	800	512	356	261	200	158	128
	m	2	3	4	5	6	7	8	9	10

12901000 230V black
13901000 120V black



COMPATIBLE LAMPS

CP55	G22	2000W	230V/240V	3200K	480 hrs
CP75	G22	2000W	230V/240V	3200K	480 hrs
CP92	G22	2000W	230V/240V	3200K	400 hrs
CP72	GY16	2000W	230V/240V	3200K	480 hrs
CP91	G22	2500W	230V/240V	3200K	400 hrs
CYX	G38	2000W	120V	3200K	350 hrs

LDR recommends Philips lamps

ACCESSORIES

20100107	colour frame, black
20100307	4-leaf barndoor, black
20101104	alu-grip clamp for BS spigot
20101300	safety bond

PRODUCT SPECS

lens type
200mm dia. Fresnel

reflector
87,5mm dia. glass

microswitch
double-pole

colour frame
245x245mm

throw
3-20 m

beam angle
10°-70°

lamp base
G22 (230V) - G38 (120V)

weight
10,4 kg (230V) - 11,5 kg (120V)

Compact, lightweight and powerful 2/2.5KW fresnel spotlight. It's ideal for all those applications in larger venues where the luminaires are difficult to access and whose position needs to be changed frequently.

A colour frame, safetyguard and 1,5m mains cable are included as standard.

Illuminatore fresnel da 2/2500W estremamente compatto, leggero e potente, dotato di forcella per comando a palo della posizione orizzontale e verticale.

Ideale per tutte quelle installazioni con illuminatori di difficile accesso e la cui posizione debba essere modificata di frequente. Fornito di serie completo di telaio porta-gelatina, rete di protezione e 1,5m cavo di alimentazione.

On request also available with GY16 lamp-base(230V only).

Su richiesta disponibile anche con porta-lampada GY16 (solo 230V).

PHOTOMETRIC DATA CP75

	m Ø	2,3	2,5	2,7	2,9	3,1	3,3	3,5	3,7	3,9
SPOT	lux	1.563	1.331	1.148	1.000	879	779	694	623	563
	m	12	13	14	15	16	17	18	19	20
FLOOD	m Ø	4,2	5,6	7,0	8,4	9,8	11,2	12,6	14,0	15,4
	lux	2.200	1.238	792	550	404	309	244	198	164
	m	3	4	5	6	7	8	9	10	11

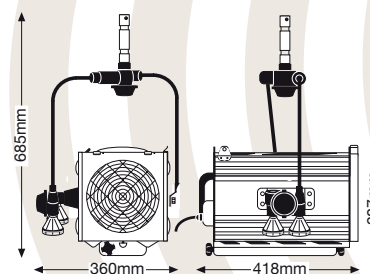

12806050 black
 12806051 white
 12806052 silver



COMPATIBLE LAMPS

P2/10	R7s	625W	230V/240V	3200K	150 hrs
P2/7	R7s	1000W	230V/240V	3200K	200 hrs
P2/12	R7s	1250W	230V/240V	3200K	200 hrs

LDR recommends Philips lamps

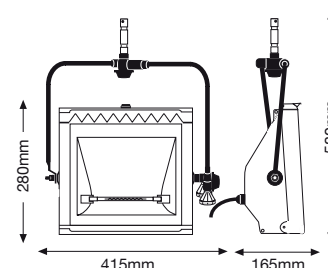

ACCESSORIES

20100112	colour frame, black
20100112B	colour frame, white
20100112C	colour frame, silver
20101412	spare clear safety glass
20100492	4-leaf barndoor, black
20100492B	4-leaf barndoor, white
20100492	4-leaf barndoor, silver
20101104	alu-grip clamp for BS spigot
20101300	safety bond

PRODUCT SPECS

reflector	aluminium, asymmetrical
microswitch	double-pole
colour frame	290x270mm
throw	2-10m
weight	7kg

Asymmetric 1Kw floodlight featuring a pole-operated stirrup for the control of pan and tilt. Ideal to evenly illuminate a backcloth, cyclorama or scenic pieces from an oblique angle in larger venues or TV studios. A colour frame, safety glass and 1,5m mains cable are also included for each unit.

Diffusore asimmetrico da 1000W dotato di forcina per comando a palo. Ideale per l'illuminazione omogenea di fondali e parti di scena, anche da angolazioni oblique, in teatri o studi televisivi.

Fornito di serie di telaio porta-gelatina, vetro di protezione e 1,5m cavo di alimentazione.

Available to special order with extended front chassis for longer gel life.

Su richiesta disponibile anche con telaio anteriore esteso per gelatine dai colori saturi.

PHOTOMETRIC DATA P2/7

HORIZONTAL	m Ø	4,8	7,2	9,5	11,9	14,3	16,7	19,1	21,5	23,8
	lux	4.688	2.083	1.172	750	521	383	293	231	188
m	2	3	4	5	6	7	8	9	10	
VERTICAL	m Ø	5,7	8,6	11,4	14,3	17,1	20,0	22,9	25,7	28,6
	lux	4.950	2.200	1.238	792	550	404	309	244	198
m	2	3	4	5	6	7	8	9	10	

12806060 black
 12806061 white
 12806062 silver



COMPATIBLE LAMPS

P2/10	R7s	625W	230V/240V	3200K	150hrs
P2/7	R7s	1000W	230V/240V	3200K	200hrs
P2/12	R7s	1250W	230V/240V	3200K	200hrs

LDR recommends Philips lamps

Symmetric 1Kw floodlight featuring a pole-operated stirrup for the control of pan and tilt. Ideal for applications even in larger venues where a wide, even wash of light for general lighting purposes is needed. A colour frame, safety glass and 1,5m mains cable are also included for each unit.

Diffusore simmetrico da 1000W dotato di forcilla per comando a palo. Ideale all'impiego anche su grandi aree per l'illuminazione generale d'ambiente in installazioni teatrali o in studi televisivi. Fornito di serie di telaio porta-gelatina, vetro di protezione e 1,5m cavo di alimentazione.

Available to special order with extended front chassis for longer gel life.

Su richiesta disponibile anche con telaio anteriore esteso per gelatine dai colori saturi.

ACCESSORIES

20100112	colour frame, black
20100112B	colour frame, white
20100112C	colour frame, silver
20101412	spare clear safety glass
20100492	4-leaf barndoor, black
20100492B	4-leaf barndoor, white
20100492	4-leaf barndoor, silver
20101104	alu-grip clamp for BS spigot
20101300	safety bond

PRODUCT SPECS

reflector	aluminium, symmetrical
microswitch	double-pole
colour frame	290x270mm
throw	2-10m
weight	7kg

PHOTOMETRIC DATA P2/7

HORIZONTAL	PHOTOMETRIC DATA P2/7									
	m Ø	4,0	6,0	8,0	10,0	12,0	14,0	16,0	18,0	20,0
lux	4.875	2.167	1.219	750	542	398	305	241	195	
m	2	3	4	5	6	7	8	9	10	
VERTICAL	PHOTOMETRIC DATA P2/7									
	m Ø	4,4	6,5	8,7	10,9	13,1	15,3	17,5	19,6	21,8
	lux	5.125	2.278	1.281	820	569	418	320	253	205
m	2	3	4	5	6	7	8	9	10	

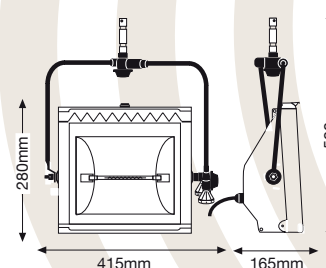

NOTA F/PC 1200 MOVING



PC Moving: 14852000 black

F Moving: 14851000 black



COMPATIBLE LAMPS

CP70	GX9.5	1000W	230V/240V	3200K	240 hrs
T19	GX9.5	1000W	230V/240V	3050K	900 hrs
CP90	GX9.5	1200W	230V/240V	3200K	240 hrs
T29	GX9.5	1200W	230V/240V	3000K	480 hrs

LDR recommends Philips lamps

PRODUCT SPECS

lens type

150mm dia. Fresnel / pebble convex

reflector

100mm dia. aluminium

microswitch

double-pole

colour frame

185x185 mm

throw

2-15 m

beam angle

10°-56° F / 8°-60° PC

lamp base

GX9.5

weight

15,5 kg including Xpress 19

The LDR range of moving-yoke luminaires harnesses the complete reliability of the Xpress colour scrollers, Nota and Tono F/PC advanced optics and mechanics, with LI high-specification moving yokes. They all feature pan, tilt and zoom remote control, built-in PSU and a vast choice of options for the professionals.

Standard delivery includes:

Nota 1200 Moving:

Nota F or PC1200, Xpress 19 with 21 LEE colours, built-in safety bond and 2 mega clamps for rigging.

Tono 2000 Moving:

Tono F or PC 2000, Xpress 26 with 21 LEE colours, built-in safety bond and 2 mega clamps for rigging.

ACCESSORIES

20100319	4-leaf barndoor, aluminium
20620019	spare gel string 21 frames
20621019	spare gel string 21 frames special sequence

PHOTOMETRIC DATA CP90

	m Ø	1,2	1,4	1,6	1,7	1,9	2,1	2,3	2,4	2,6
SPOT	lux	2.612	2.000	1.580	1.280	1.058	889	757	653	569
	m	7	8	9	10	11	12	13	14	15
FLOOD	m Ø	2,1	3,2	4,3	5,3	6,4	7,4	8,5	9,6	10,6
	lux	3.200	1.422	800	512	356	261	200	158	128
	m	2	3	4	5	6	7	8	9	10

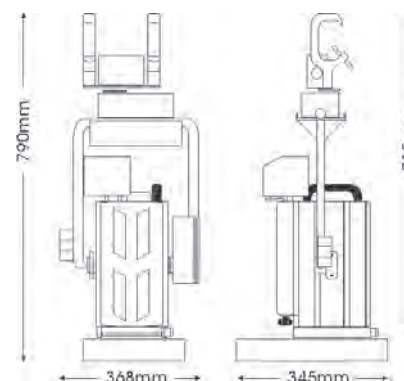

TONO F/PC 2000 MOVING



F Moving: 14901000 black

PC Moving: 14902000 black

OPERATIONAL

power supply
built-in

pan
pan drive 16 bit with heat protection shield.
Max pan angle 364°
Max speed: 30"

tilt
tilt drive 16 bit.
Max tilt angle 94°
Max speed 19"

focus control
focus drive 8 bit;
motorized control spot to flood max speed: 6"

setup
built-in microprocessor with LED display and buttons

power supply
rated voltage: 95-264 VAC, Neutrik Powercon connector.
Power cable included

DMX in + out
standard Neutrik 5-pin connectors

DMX channels
8

fuse
1,5A 32mm slow blow

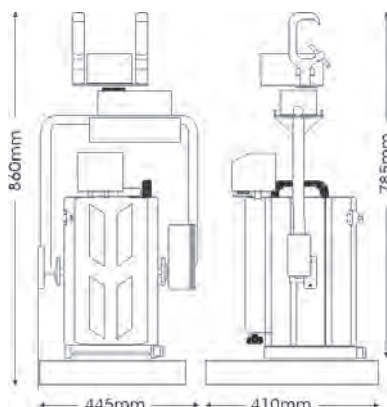

COMPATIBLE LAMPS

CP55 G22 2000W 230V/240V 3200K 480 hrs

CP75 G22 2000W 230V/240V 3200K 480 hrs

CP92 G22 2000W 230V/240V 3200K 400 hrs

CP91 G22 2500W 230V/240V 3200K 400 hrs

LDR recommends Philips lamps

PRODUCT SPECS

lens type
200mm dia.
Fresnel / pebble convex

reflector
87,5mm dia. glass

microswitch
double-pole

colour frame
245x245mm

throw
3-20m

beam angle
10°-70° F / 9°-70° PC

lamp base
G22

weight
20kg including Xpress 26

PHOTOMETRIC DATA FRESNEL CP75

	m Ø	2,3	2,5	2,7	2,9	3,1	3,3	3,5	3,7	3,9
SPOT	lux	1.563	1.331	1.148	1.000	879	779	694	623	563
	m	12	13	14	15	16	17	18	19	20
FLOOD	m Ø	4,2	5,6	7,0	8,4	9,8	11,2	12,6	14,0	15,4
	lux	2.200	1.238	792	550	404	309	244	198	164
	m	3	4	5	6	7	8	9	10	11

ACCESSORIES

- 20100319 4-leaf barndoor, aluminium
- 20620019 spare gel string 21 frames
- 20621019 spare gel string 21 frames special sequence

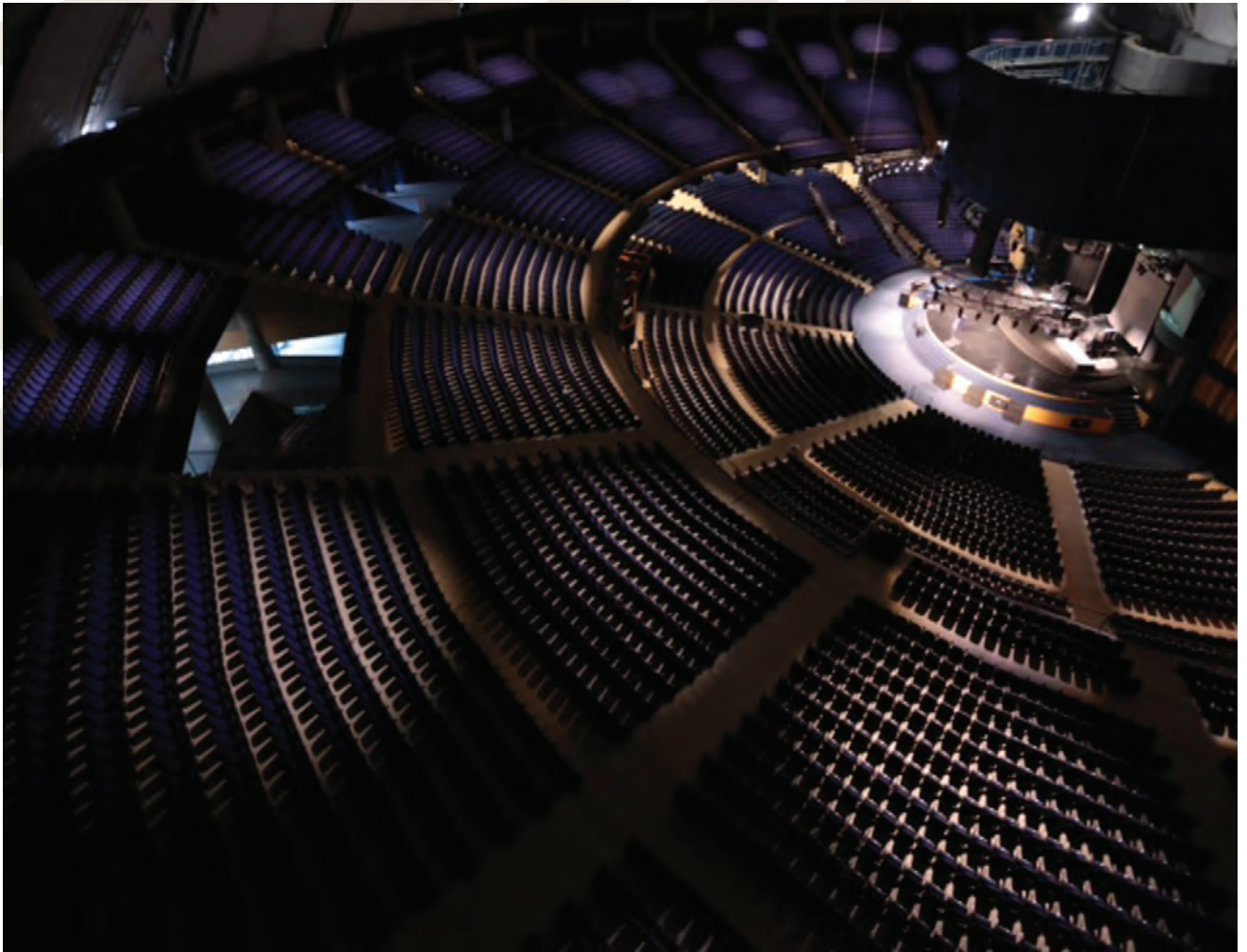

COLOUR SCROLLERS



XPRESS 13 DMX/RDM



20106013 black



ELECTRICAL

current requirement
0.6 amps (+24 V DC)

power consumption
11W

OPERATIONAL

gel string capacity
8-11-16- 21 frames

gel string movement
continuous/step,
remotely controlled

scroll speed
min. 1,6 sec
(head to tail with 21 frames)

gel string cooling
single fan; 5 preset variable
speeds or remotely
controlled

motor
2 DC servo motors directly
fixed to the rollers

DMX/power in & out
XLR 4-pin male – DMX512
and 24V DC power

daisy chaining
6 or 24 units using PDU6
or PDU24

DMX channels
1 to 5 DMX addressable
channels

operational modes
continuous or step

The Xpress 13, DMX/RDM-controllable colour scroller, is ideal for use on LDR 500/650W luminaires or any with a front aperture up to 135mm. It features 4 front attachments for an optional rotating barndoor and is supplied with fitted 21-colour Lee filter gel string, a 160x160mm rear mounting plate and black steel safety bond.

Xpress 13, scroller a controllo DMX/ RDM è adatto a tutti gli illuminatori LDR da 500/650W e ad altri illuminatori con apertura frontale fino a 135mm.

E' dotato di 4 supporti frontali per il fissaggio di un paraluce 4 alette accessorio e viene fornito completo di stringa di gelatina con 21 colori Lee, piastra di montaggio 160x160mm e cavo di sicurezza nero.

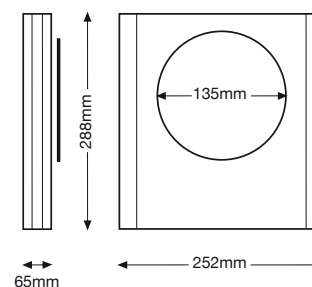

PRODUCT SPECS

construction
sturdy aluminium

paint finish
black epoxy powder coating

rear mounting plate
160x160mm, fitted

barndoor plate
185x185mm

safety cable
60cm, steel, included

weight
2,2kg

ACCESSORIES

20600002	rear mounting plate 125x125mm
20600003	rear mounting plate 150x150mm
20100313	4-leaf barndoor, aluminium
20620013	spare gel string 21 frames, Lee filter, standard sequence
20621013	spare gel string 21 frames, Lee filter, special sequence

XPRESS 19 DMX/RDM



20106019 black



ELECTRICAL

current requirement

0.6 amps (+24 V DC)

power consumption

12W

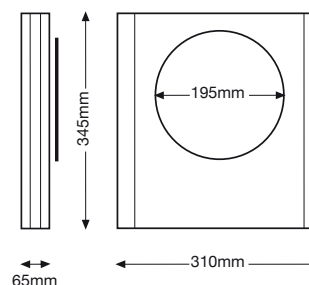

PRODUCT SPECS

construction

sturdy aluminium

paint finish

black epoxy powder coating

rear mounting plate

253x253mm, fitted

barndoor plate

215x215mm

safety cable

60cm, steel, included

weight

2,7kg

OPERATIONAL

gel string capacity

8-11-16- 21 frames

gel string movement

continuous/step,
remotely controlled

scroll speed

min. 1,9 sec
(head to tail with 21 frames)

gel string cooling

single fan; 5 preset variable
speeds or remotely
controlled

motor

2 DC servo motors directly
fixed to the rollers

DMX/power in & out

XLR 4-pin male – DMX512
and 24V DC power

daisy chaining

6 or 24 units using PDU6
or PDU24

DMX channels

1 to 5 DMX addressable
channels

operational modes

continuous or step

The Xpress 19, DMX/RDM-controllable colour scroller, is designed for use with all LDR 1/1,2KW luminaires or any with a front aperture up to 195mm.

It features 4 front attachments for an optional rotating barndoor and is supplied with fitted 21-colour Lee filter gel string, a 253x253mm rear mounting plate and black steel safety bond.

Xpress 19, scroller a controllo DMX/ RDM è adatto a tutti gli illuminatori LDR da 1/1,2KW e ad altri illuminatori con apertura frontale fino a 195mm. E' dotato di 4 supporti frontali per il fissaggio di un paraluce 4 alette accessorio e viene fornito completo di stringa di gelatina con 21 colori Lee, piastra di montaggio 253x253mm e cavo di sicurezza nero.

ACCESSORIES

- | | |
|----------|--|
| 20600006 | rear mounting plate
185x185mm |
| 20100319 | 4-leaf barndoor, aluminium |
| 20620019 | spare gel string 21 frames,
Lee filter, standard sequence |
| 20621019 | spare gel string 21 frames,
Lee filter, special sequence |

XPRESS 26 DMX/RDM



20106026 black



ELECTRICAL

current requirement
0.6 amps (+24 V DC)

power consumption
13W

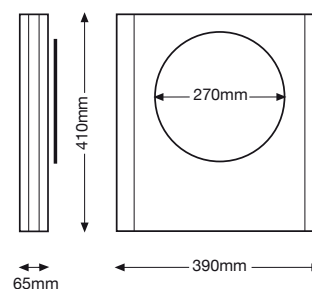

OPERATIONAL

gel string capacity
8-11-16- 21 frames

gel string movement
continuous/step,
remotely controlled

scroll speed
min. 3,2 sec
(head to tail with 21 frames)

gel string cooling
double fan; 5 preset variable
speeds or remotely
controlled

motor
2 DC servo motors directly
fixed to the rollers

DMX/power in & out
XLR 4-pin male – DMX512
and 24V DC power

daisy chaining
6 or 24 units using PDU6
or PDU24

DMX channels
1 to 5 DMX addressable
channels

operational modes
continuous or step

The Xpress 26, DMX/RDM-controllable colour scroller, is ideal for use with those LDR 2KW luminaires featuring a 245x245mm colour frame or any with a front aperture up to 270mm. It features 4 front attachments for an optional rotating barndoor and is supplied with fitted 21-colour Lee filter gel string, a 313x313mm rear mounting plate and black steel safety bond.

Xpress 26, scroller a controllo DMX/ RDM è adatto a tutti gli illuminatori LDR da 2KW con portagelatina da 245x245mm e ad altri illuminatori con apertura frontale fino a 270mm. E' dotato di 4 supporti frontali per il fissaggio di un paraluce 4 alette accessorio e viene fornito completo di stringa di gelatina con 21 colori Lee, piastra di montaggio 313x313mm e cavo di sicurezza nero.

ACCESSORIES

- | | |
|----------|---|
| 20600007 | rear mounting plate
245x245mm |
| 20100326 | 4-leaf barndoor, aluminium |
| 20620026 | spare gel string 21 frames,
Lee filter, standard sequence
spare gel string 21 frames,
Lee filter, special sequence |
| 20621026 | Lee filter, special sequence |

PRODUCT SPECS

construction
sturdy aluminium

paint finish
black epoxy powder coating

rear mounting plate
313x313mm, fitted

barndoor plate
313x313mm

safety cable
60cm, steel, included

weight
3,4kg

20103006

PRODUCT SPECS

construction
sturdy aluminium housing.
Metal shafts.

paint finish
black epoxy powder paint

rear mounting plate
185x185mm, fitted

barndoor plate
215x215mm

safety cable
60cm, steel, included

shutter blades
12 horizontal steel blades
with straight borders con-
nected to a gearbox

weight
2,4kg

ELECTRICAL

current requirement
0.6 amps (+24 V DC)

power consumption
11W

OPERATIONAL

resolution
8 bits (256 steps)
12 bits (4.096 steps)

motor
one DC servo motor

close-to-open speed
0,2 sec to 45 sec, on 8 pre-
set selectable speeds, locally
or remotely controllable

step resolution
256 steps and 4.096 steps

LED display ON
selectable, 30s, 45s, 60s or
always ON

daisy chaining
6 or 24 units using PDU 6
or PDU 24

reset
locally by touch panel;
remotely by DMX512/RDM

DMX channels
max 6, depending on the
chosen settings



DMX512 and RDM-controllable motorized dimming shutter, designed to provide a smooth control of light intensity on non dimmable discharge fixtures. It features an extremely quiet and precise operation at a close-to-open speed varying from 0,5 sec to 45 seconds and ensures no alterations of colour temperature. Oscura 19 is fitted with 4 slots for an accessory 4-leaf barndoor and is supplied with a 185x185mm rear mounting plate and a 60cm black safety bond.

Attenuatore luce motorizzato, a controllo DMX512 e RDM, pensato per garantire un controllo preciso dell'intensità luce su illuminatori a scarica non dimmerabili. Dispone di 12 lame in acciaio a bordo liscio, garantisce un funzionamento particolarmente silenzioso e preciso e non altera la temperatura di colore della lampada utilizzata. Dispone di 4 supporti per il fissaggio di un paraluce accessorio e viene fornito completo di piastra di montaggio 185x185mm e di cavo di sicurezza in acciaio da 60cm.

ACCESSORIES

- 20106260 PDU 6M power distribution unit for up to 6 dimmers, DMX/RDM
- 20106020 PDU 1 power distribution unit for 1 dimmer, DMX
- 20106024 PDU 24 power distribution unit for up to 24 dimmers, DMX
- 20100319 4-leaf barndoor, aluminium

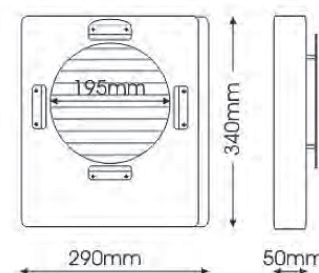

PDU POWER DISTRIBUTION UNIT



The PDU (power distribution unit) distributes DC power (24V) and the DMX data signal through the XLR4- pin female plug to max. 1, 6 or 24 Xpress colour scrollers.

The DMX signal can be daisy-chained from the PDU to any other DMX device. Each PDU is delivered with a hook clamp, CEE22 power cord and steel safety bond.

Il PDU (power distribution unit) distribuisce sia l'alimentazione (24V) sia il segnale di controllo DMX ad un massimo di 1, 6 o 24 Xpress collegati in sequenza.

Il segnale DMX può trasmesso in sequenza dal PDU a qualsiasi apparecchiatura a controllo DMX. Il PDU viene fornito completo di gancio di sospensione, cavo di alimentazione con CEE22 e cavo di sicurezza in acciaio.

PRODUCT SPECS

construction

sturdy aluminium housing

paint finish

black epoxy powder coating

safety cable

60cm black safety cable, supplied

ACCESSORIES

20610003	DMX XLR-4 pin cable 3m
20610005	DMX XLR-4 pin cable 5m
20610010	DMX XLR-4 pin cable 10m
20610015	DMX XLR-4 pin cable 15m
20610020	DMX XLR-4 pin cable 20m
20610025	DMX XLR-4 pin cable 25m

Special-lenght cables are available on request.

PDU 7

20106020 black

Power distribution unit for 1 scroller.

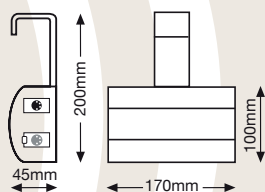

weight
1,3 kg



ELECTRICAL

power input

100V-240V 50/60Hz

power output

24V DC

OPERATIONAL

DMX input to PDU

XLR 5-pin male

DMX / power output

XLR 4-pin-female

DMX 512 + 24V

DMX channels

1 or 2 channels per scroller

PDU 6

- 20106260 black PDU 6M DMXS12 - RDM
- 20106160 black PDU 6/8 DMXS12

Power and DMX512/RDM Signal Distribution Unit for 1 to 6 scrollers.



OPERATIONAL

- conforms to RDM El.20-2006 standards
- compatible with traditional colour scroller systems
- XLR5F through connector
- XLR4F signal + power connector
- power selection switch: allows selection between 230V AC and 115V AC
- 3-level switch to select the working mode: Normal. Filter and Bypass

ELECTRICAL

power input
230V or 115V 50/60Hz, selectable

power consumption
800W (max)

fuse rating
3A at 230V - 5A at 115 V

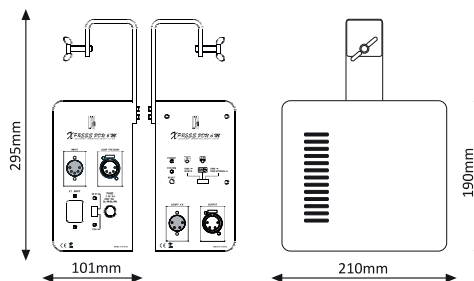

weight
5,5 kg

PDU 24

- 20106024 black

Power distribution unit for 1 to 24 scrollers.



ELECTRICAL

power input
210V-240V 50/60Hz, (90V-120V selectable)

fuse rating
5A / 230V - 10A / 120V

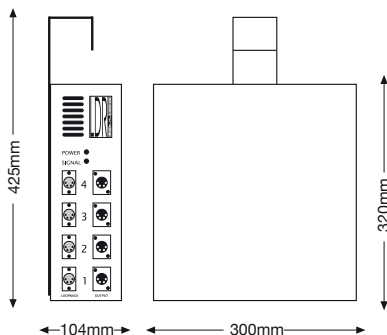

weight
17,5 kg

OPERATIONAL

DMX input to PDU
XLR 5-pin male

DMX daisy chaining
through XLR 5-pin-male from PDU

DMX / power output
XLR 4-pin-female
DMX 512+24V

DMX channels
1 per colour changer selected on the scroller

GOBO WIZARD



Specially designed to fit the Soffio profile range, this software gives the unique possibility of creating customized gobos printed on a standard transparency film.

Theatre backgrounds as well as logos or any other kind of text and image can be printed out and projected.

The program runs on all Windows operating systems (95, 98, ME, NT, Xp, Xp pro) and can be installed in five different languages.

Gobo Wizard is an easy and cost effective way to create customized gobos and it's a perfect tool for drama school and to create new theatre effects for commercial display.

Gobo Wizard is a free-ware and can be downloaded from the LDR website at www.ldr.it

Specificamente progettato a complemento della gamma di sagomatori Soffio, questo software offre la possibilità di creare gobo personalizzati stampati su pellicola trasparente da video-proiezione (fogli da lavagna luminosa).

Con Gobo Wizard potete avere a vostra disposizione, in brevissimo tempo ed a costi ridottissimi, tutti i gobo a colori di cui avete bisogno.

Il programma funziona con tutti i sistemi operativi Windows (95, 98, ME, NT, Xp, Xp pro) ed è installabile in 5 lingue.

Gobo Wizard è un free-ware ed è scaricabile dal sito LDR a www.ldr.it



gobo wizard®

FLIGHT CASE

20107180 for all Canto models + Astro

20107081 for Canto 250 msd

Stackable, high quality, ATA approved flight case with braking wheels.

Houses 1 Canto or Astro followspot fitted with colour changer, ballast unit, tripod, spigot, iris diaphragm, lamp.

Extra room at the bottom for cables or other accessories.

Dimensions:

112cm x 57cm x 71cm (h), including wheels

Flight case di elevato standard qualitativo, impilabile, approvato ATA, completo di ruote frenanti.

Alloggia: 1 seguipersona Canto o Astro con cambia-colori montato, ballast, stativo, perno per stativo, diaframma ad iride e lampada.

Ulteriore spazio disponibile per cavi o altri accessori.

Dimensioni:

117cm x 57cm x 71cm (h), ruote comprese





PRODUCT SUMMARY

THEATRICAL

Fresnel Luminaires

TEMPO F 650 PLUS



- 10601000 black
- 10601001 white
- 10601002 silver

watt: 300/500/650
beam angle: 7° - 60°
net weight: 4kg
lamp base: GY9.5
throw: 2-10m

TEMPO F 650 PRO



- 10601200 black
- 10601201 white
- 10601202 silver

watt: 300/500/650
beam angle: 7° - 60°
net weight: 4kg
lamp base: GY9.5
throw: 2-10m

SUONO F 650 PLUS



- 10601010 black
- 10601011 white
- 10601012 silver

watt: 300/500/650
beam angle: 7° - 60°
net weight: 4,1kg
lamp base: GY9.5
throw: 2-10m

ARIA F 1000 PLUS



- 10801000 black
- 10801001 white
- 10801002 silver

watt: 650/1000/1200
beam angle: 10° - 56°
net weight: 5,6kg
lamp base: GX9.5
throw: 2-15m

NOTA F 1200 PLUS



- 10851000 black
- 10851001 white
- 10851002 silver

watt: 650/1000/1200
beam angle: 10° - 56°
net weight: 5,8kg (230V) 6kg (120V)
lamp base: GX9.5 (230V) G22 (120V)
throw: 2-15m

Pebble-convex (PC) and Polished Plano-convex (PPC) Luminaires

TEMPO 650 PLUS



- | | | |
|-----------|-------------------|------------|
| PC | ● 10602000 black | ● 10602100 |
| | ○ 10602001 white | ○ 10602101 |
| | ● 10602002 silver | ● 10602102 |

watt: 300/500/650
beam angle: 7° - 58°
net weight: 4,2kg
lamp base: GY9.5
throw: 2-10m

TEMPO 650 PRO



- | | | |
|-----------|-------------------|------------|
| PC | ● 10602200 black | ● 10602300 |
| | ○ 10602201 white | ○ 10602301 |
| | ● 10602202 silver | ● 10602302 |

watt: 300/500/650
beam angle: 7° - 58°
net weight: 4,2kg
lamp base: GY9.5
throw: 2-10m

SUONO 650 PLUS



- | | | |
|-----------|-------------------|------------|
| PC | ● 10602010 black | ● 10602110 |
| | ○ 10602011 white | ○ 10602111 |
| | ● 10602012 silver | ● 10602112 |

watt: 300/500/650
beam angle: 7° - 58°
net weight: 4,3kg
lamp base: GY9.5
throw: 2-10m

ARIA 1000 PLUS



- | | | |
|-----------|-------------------|------------|
| PC | ● 10802000 black | ● 10802100 |
| | ○ 10802001 white | ○ 10802101 |
| | ● 10802002 silver | ● 10802102 |

watt: 650/1000/1200
beam angle: 8° - 60°
net weight: 6kg
lamp base: GX9.5
throw: 2-17m

NOTA 1200 PLUS



- | | | |
|-----------|-------------------|------------|
| PC | ● 10852000 black | ● 10852100 |
| | ○ 10852001 white | ○ 10852101 |
| | ● 10852002 silver | ● 10852102 |

watt: 650/1000/1200
beam angle: 8° - 60°
net weight: 6,2kg (230V) 6,4kg (120V)
lamp base: GX9.5 (230V) G22 (120V)
throw: 2-17m

THEATRICAL

Fresnel Luminaires

TONO F 2000 PLUS



- 10901000 230V
- 11901000 120V

watt: 1200/2000/2500
beam angle: 10° - 70°
net weight: 9kg (230V) 10,1kg (120V)
lamp base: G22 (230V) G38 (120V)
throw: 3-20m

Pebble-convex (PC) and Polished Plano-convex (PPC) Luminaires

TONO 2000 PLUS



- | | | |
|-----------------|------------|------------|
| PC | | PPC |
| ● 10902000 230V | ● 10902100 | |
| ● 11902000 120V | ● 11902100 | |

watt: 1200/2000/2500
beam angle: 9° - 70°
net weight: 10,3kg (230V) 11,4kg (120V)
lamp base: G22 (230V) G38 (120V)
throw: 3-20m

Double condenser profiles

SUONO 10/28 PLUS



- 10604020 black
- 10604021 white
- 10604022 silver

watt: 300/500/650
beam angle: 10° - 28°
net weight: 7,5kg
lamp base: GY9,5
throw: 2-15m

SUONO 20/40 PLUS



- 10604030 black
- 10604031 white
- 10604032 silver

watt: 300/500/650
beam angle: 20° - 40°
net weight: 7kg
lamp base: GY9,5
throw: 2-15m

NOTA 8/22



- 10853020 black
- 10853021 white
- 10853022 silver

watt: 650/1000/1200
beam angle: 8° - 22°
net weight: 14,3kg
lamp base: GX9,5
throw: 5-25m

NOTA 18/36



- 10853030 black
- 10853031 white
- 10853032 silver

watt: 650/1000/1200
beam angle: 18° - 36°
net weight: 12,3kg
lamp base: GX9,5
throw: 5-18m

NOTA 30/55



- 10853040 black
- 10853041 white
- 10853042 silver

watt: 650/1000/1200
beam angle: 30° - 55°
net weight: 11,9kg
lamp base: GX9,5
throw: 4-12m

TONO 8/22



- 10903020 black

watt: 2000
beam angle: 8° - 22°
net weight: 14,7kg
lamp base: GY16
throw: 6-30m

TONO 18/36



- 10903030 black

watt: 2000
beam angle: 18° - 36°
net weight: 14kg
lamp base: GY16
throw: 6-23m

TONO 30/55



- 10903040 black

watt: 2000
beam angle: 30° - 55°
net weight: 13,7kg
lamp base: GY16
throw: 4-12m

THEATRICAL

Discharge Followspots

CANTO 250 msd

● 10207080 black



watt: 250, msd
beam angle: 10° - 28°
net weight: 13,6kg
lamp base: GY9,5
throw: 2-15m

CANTO 250 HR MK2

● 10257180 black
 ● 10257181 white



watt: 250, HR
beam angle: 8° - 22°
net weight: 15,1kg
lamp base: GZY9,5
throw: 10-20m

CANTO 575 msd/msr

● 10577180 230V ● 11577280 100 V
 ● 10577280 250V ● 11577180 120V



watt: 575, msd/msr
beam angle: 8° - 22°
net weight: 19,8kg - ballast 16,5/28 (120V)
lamp base: GX9,5
throw: 10-30m

CANTO 700 msd/msr

● 10707180 230V
 ● 10707280 250V
 ● 11707180 120V



watt: 700, msd/msr
beam angle: 8° - 22°
net weight: 19,8kg - ballast 16,5/28 (120V)
lamp base: G22
throw: 10-35m

CANTO 1200 msd/msr

● 10857180 230V ● 11857280 100V
 ● 10857280 250V ● 11857180 120V



watt: 1200, msd/msr
beam angle: 8° - 22°
net weight: 19,8kg - ballast 16,5/28 (120V)
lamp base: G22
throw: 10-40m

CANTO 1500 msr FF

● 10867180 230V
 ● 11867180 120V



watt: 1500, msr
beam angle: 8° - 22°
net weight: 22,0kg - ballast 8,5kg
lamp base: PGJX50
throw: 2-45m

CANTO 2000 msr FF

10907180 black 180/265V



watt: 2000, msr
beam angle: 8° - 22°
net weight: 20,5kg - ballast 8,5kg
lamp base: PGJX50
throw: 10-50m

TH Followspots

CANTO 1200 TH MK2

● 10857170 230V
 ● 11857170 120V



watt: 1200 (230V) - 1000 (120V)
beam angle: 8° - 22°
net weight: 18,0kg
lamp base: GX9,5 (230V) G22 (120V)
throw: 10-20m

CANTO 2000 TH MK2

● 10907170 230V
 ● 11907170 120V



watt: 2000
beam angle: 8° - 22°
net weight: 18,0kg
lamp base: GY16
throw: 10-30m

THEATRICAL

CANTO + ASTRO FOLLOWSPOT KIT

Any model of the Canto and Astro range is available in kit, including the chosen followspot and relevant lamp, colour changer, tripod and flight case.



Floods

RIMA A 500 F / PRO



- | | | | |
|----------|------------|--------|------------|
| F | ● 10506050 | black | ● 10516050 |
| | ○ 10506051 | white | ○ 10516051 |
| | ● 10506052 | silver | ● 10516052 |

watt: 200/300/500
net weight: 2,0kg (F) / 2,6kg (PRO)
lamp base: R7S
throw: 2-5m

RIMA S 500 F / PRO



- | | | | |
|----------|------------|--------|------------|
| F | ● 10506060 | black | ● 10516060 |
| | ○ 10506061 | white | ○ 10516061 |
| | ● 10506062 | silver | ● 10516062 |

watt: 200/300/500
net weight: 2,0kg (F) / 2,6kg (PRO)
lamp base: R7S
throw: 2-5m

INNO A 1000



- 10806050 black
- 10806051 white
- 10806052 silver

watt: 650/1000/1250
net weight: 5,3kg
lamp base: R7S
throw: 2-10m

INNO S 1000



- 10806060 black
- 10806061 white
- 10806062 silver

watt: 650/1000/1250
net weight: 5,3kg
lamp base: R7S
throw: 2-10m

SCENA 500



● 10305060 black

watt: 200/300/500
net weight: 1,3kg
lamp base: R7S
throw: 2-10m

SCENA 1000



● 10805060 black

watt: 1000/1250
net weight: 3,3kg
lamp base: R7S
throw: 2-10m

Par cans

PALCO 64 PRO



● 10808011 black

watt: 1000
beam angle: 43° (spot)
net weight: 1,8kg
lamp base: GX16D
throw: 2-15m

LED

Double condenser profiles + followspots

ALBA 8/22 W
ALBA 8/22 C



- 01203020 3200K, black
- 01203021 3200K, white
- 01203120 5600k, black
- 01203121 5600k, white

watt: 200W white LED
beam angle: 8° - 22°
control signal: DMX512 - RDM
dimmer: PWM, built-in
net weight: 16,9kg
throw: 2-15m

ALBA 18/36 W
ALBA 18/36 C



- 01203030 3200K, black
- 01203031 3200k, white
- 01203130 5600k, black
- 01203131 5600k, white

watt: 200W white LED
beam angle: 18° - 36°
control signal: DMX512 - RDM
dimmer: PWM, built-in
net weight: 16,1kg
throw: 2-15m

ALBA 30/55 W
ALBA 30/55 C



- 01203040 3200K, black
- 01203041 3200k, white
- 01203140 5600k, black
- 01203141 5600k, white

watt: 200W white LED
beam angle: 30° - 55°
control signal: DMX512 - RDM
dimmer: PWM, built-in
net weight: 15,9kg
throw: 2-10m

ASTRO 200 W
ASTRO 200 C



- 01207070 3200K, black
- 01207080 5600k, black

watt: 200W white LED
beam angle: 8° - 22°
control signal: DMX512 - RDM
dimmer: PWM, built-in
net weight: 19,5kg
throw: 2-20m

ARCHITECTURAL

Discharge floods

RIMA A 70



- 10076050 black
- 10076051 white
- 10076052 silver

watt: 70, CDM
net weight: 3,8kg
lamp base: RX7s
throw: 2-5m

RIMA S 70



- 10076060 black
- 10076061 white
- 10076062 silver

watt: 70, CDM
net weight: 3,8kg
lamp base: RX7s
throw: 2-5m

RIMA A 150



- 10156050 black
- 10156051 white
- 10156052 silver

watt: 150, CDM
net weight: 3,8kg
lamp base: RX7s
throw: 2-10m

RIMA S 150



- 10156060 black
- 10156061 white
- 10156062 silver

watt: 150, CDM
net weight: 3,8kg
lamp base: RX7s
throw: 2-10m

ARCHITECTURAL

Discharge Fresnel luminaires

SOFFIO F 70



- 10071080 black
- 10071081 white
- 10071082 silver

watt: 70, CDM
beam angle: 7° - 63°
net weight: 5,5kg
lamp base: G12
throw: 2-10m

SOFFIO F150



- 10151080 black
- 10151081 white
- 10151082 silver

watt: 150, CDM
beam angle: 7° - 63°
net weight: 6kg
lamp base: G12
throw: 2-15m

SUONO F 250 msd



- 10201080 black
- 10201081 white
- 10201082 silver

watt: 250, msd
beam angle: 7° - 63°
net weight: 8,6kg
lamp base: GY9,5
throw: 2-20m

Discharge profiles

SOFFIO 10/28 70W



- 10073020 black
- 10073021 white
- 10073022 silver

watt: 70, CDM
beam angle: 10° - 28°
net weight: 8,5kg
lamp base: G12
throw: 2-10m

SOFFIO 10/28 150W



- 10153020 black
- 10153021 white
- 10153022 silver

watt: 150, CDM
beam angle: 10° - 28°
net weight: 9kg
lamp base: G12
throw: 2-15m

SOFFIO 20/40 70W



- 10073030 black
- 10073031 white
- 10073032 silver

watt: 70, CDM
beam angle: 20° - 40°
net weight: 8kg
lamp base: G12
throw: 2-10m

SOFFIO 20/40 150W



- 0153030 black
- 0153031 white
- 0153032 silver

watt: 150, CDM
beam angle: 20° - 40°
net weight: 8,5kg
lamp base: G12
throw: 2-15m

SUONO D 10/28



- 10203020 black
- 10203021 white
- 10203022 silver

watt: 250, msd
beam angle: 10° - 28°
net weight: 12,4kg
lamp base: GY9,5
throw: 2-20m

SUONO D 20/40



- 10203030 black
- 10203031 white
- 10203032 silver

watt: 250, msd
beam angle: 20° - 40°
net weight: 11,8kg
lamp base: GY9,5
throw: 2-20m

POLE-OPERATED

SOFFIO F 150 P.O.



- 12151080 black
- 12151081 white
- 12151082 silver

watt: 150, CDM
beam angle: 7° - 63°
net weight: 7,8kg
lamp base: G12
throw: 2-15m

SUONO F 250 P.O.



- 12201080 black
- 12201081 white
- 12201082 silver

watt: 250, msd
beam angle: 7° - 63°
net weight: 10,4kg
lamp base: GY9.5
throw: 2-20m

NOTA F 1200 P.O.



- 12851000 black
 - 12851001 white
 - 12851002 silver
- watt:** 650/1000/1200
beam angle: 10° - 56°
net weight: 7,3kg - 7,5kg (120V)
lamp base: GX9.5 - G22 (120V)
throw: 2-15m

TONO F 2000 P.O.



- 12901000 black
- watt:** 1200/2000/2500
beam angle: 10° - 70°
net weight: 10,4kg - 11.5kg (120V)
lamp base: G22 - G38 (120V)
throw: 3-20m

INNO A 1000 P.O.



- 12806050 black
 - 12806051 white
 - 12806052 silver
- watt:** 625/1000/1250
net weight: 7kg
lamp base: R7s
throw: 2-10m

INNO S 1000 P.O.



- 12806060 black
 - 12806061 white
 - 12806062 silver
- watt:** 625/1000/1250
net weight: 7kg
lamp base: R7s
throw: 2-10m

MOVING-YOKE

NOTA F/PC 1200 MOVING



- F ● 14851000 black PC ● 14852000

watt: 1000/1200
beam angle: 10° - 56°
net weight: 15,5kg including Xpress 19
lamp base: GX9.5
throw: 2-15m

TONO F/PC 2000 MOVING



- F ● 14901000 black PC ● 14902000

watt: 2000/2500
beam angle: 9° - 70°
net weight: 20kg including Xpress 26
lamp base: G22
throw: 3-20m

COLOUR SCROLLERS AND DIMMING SHUTTERS

XPRESS 13 DMX/RDM

● 20106013 black



mounting plate: 160x160mm
front aperture: 135mm
gel string capacity: 8-11-16-21 frames
control signal: DMX512 + RDM
net weight: 2,2kg

XPRESS 19 DMX/RDM

● 20106019 black



mounting plate: 253x253mm
front aperture: 195mm
gel string capacity: 8-11-16-21 frames
control signal: DMX512 + RDM
net weight: 2,7kg

XPRESS 26 DMX/RDM

● 20106026 black



mounting plate: 313x313mm
front aperture: 270mm
gel string capacity: 8-11-16-21 frames
control signal: DMX512 + RDM
net weight: 3,4kg

OSCURA 19 DIMMING SHUTTER

● 20103006 black



mounting plate: 185x185mm
front aperture: 195mm
shutter blades: 12, straight border
control signal: DMX512 + RDM
net weight: 2,4kg

POWER DISTRIBUTION UNITS

PDU 1

● 20106020 black



power distribution unit for 1 scroller or shutter
power input: 120/240V 50/60 HZ
DMX input: XLR5-pin
DMX output to scroller: XLR4-pin / 24V
net weight: 1,3kg

PDU 6M

● 20106260 black



DMX/RDM power distribution unit for up to 6 scrollers or shutters
power input: 230/115V 50/60 HZ, selectable
DMX input: XLR5-pin
net weight: 5,5kg

PDU 24

● 20106024 black



power distribution unit for 1 to 24 scrollers or shutters
power input: 120/240V 50/60 HZ
DMX input: XLR5-pin
DMX output to scroller: XLR4-pin / 24V
net weight: 17,5kg

PDU 6

● 20106160 black



DMX 512 power distribution unit for up to 6 scrollers or shutters
power input: 230/115V 50/60 HZ, selectable
DMX input: XLR5-pin
net weight: 5,5kg



PROFESSIONAL LIGHTING PRODUCTS

PHOTOGRAPHY, PRODUCTS

PIERO FASANOTTO, ITALY

PHOTOGRAPHY, INSTALLATIONS

LDR PRIVATE ARCHIVE

GRAPHICS

MARINA BELFORTI, ITALY

All rights reserved. No part of this publication may be reproduced, translated or scanned in any form or by any means without permission in writing from LDR. LDR reserves the right to alter product specifications without prior notice.

Tutti i diritti riservati. Non è consentita la riproduzione, la traduzione, la memorizzazione, l'adattamento totale o parziale con qualsiasi mezzo senza previa autorizzazione scritta di LDR. LDR si riserva il diritto di apportare qualsiasi modifica ai dati qui pubblicati senza alcun preavviso.

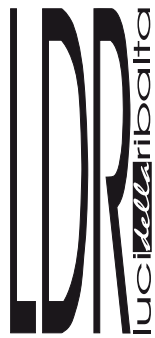

PROFESSIONAL LIGHTING PRODUCTS

